Workshop Manual

911

Carrera 4

The workshop manual is only for the internal use of the Porsche Dealer Organization.

© 1988 Dr. Ing. h.c. F. Porsche
Aktiengesellschaft
Technical Service Department
D-7140 Ludwigsburg

All rights reserved — Printed in Germany

WKD 482520

List of Repair Groups Carrera 4

General	Technical Data	Page 0.1
Repair Groups		Group
Volume 1	Maintenance, Self-diagnosis	03
	Engine, Crankcase, Suspension	10
Engine, Maintenance	Engine, Crankshaft, Pistons	13
	Engine, Cylinder Head and Valve Drive	15
	Engine, Lubrication	17
	Engine, Cooling	19
	Fuel Supply	20
	Fuel System, Electronic Injection	24
	Exhaust System/Emission Controls	26
	Starter, Power Supply, Cruise Control	27
	Ignition System	28
	Diagnosis	
Volume II	Clutch, Controls	30
	Clutch	32
Transmission (manual)	Manual Transmission, Controls, Case	34
	Manual Transmission, Gears, Shafts	35
	Differential, Transaxle System, All-Wheel Drive	39
	Diagnosis	
Volume III	Clutch, Controls	30
	Torque Converter	32
Transmission (automatic)	Automatic Transmission, Controls, Case	37
	Automatic Transmission, Gears, Shafts	38
	Differential, Transaxle System	39
	Diagnosis	
Volume IV	Front Wheel Suspension	40
	Rear Wheel Suspension, Axle Shaft	42
Chassis	Wheels, Tires, Alignment	44
	Antiblock System	45
	Brakes, Mechanical	46
	Brakes, Hydraulics, Regulator, Booster	47
	Steering	48
	Diagnosis	
Volume VI	Body-Front Section	50
	Body-Center Section	51
Body	Body-Rear Section	53
	Lids	55
	Doors	57
	Electric Sunroof	60
	Hardtop	61
	Bumpers	63
	Glasses, Window Control	64
	Exterior Equipment	66
	Interior Equipment	68
	Seats	72
	Seat Covers	74
Volume VI	Heater	80
	Ventilation	85
Heating, Ventilation, Air Condition Electrics	Air Conditioner	87
	Diagnosis	
	Instruments, Fuel Gauge, Alarm System	90
	Radio, Telephone, On-board-computer	91
	Windshield Wipers and Washer	92
	Exterior Lights, Lamps, Switches	94
	Interior Lights	96
	Diagnosis	
Volume VII	Wiring	97
Electrics Wiring Diagrams		

The workshop manual of the Carrera 4 also includes that for the Carrera 2.
The Carrera 4 acts as the basis for description of the repairs in the manual.
"Carrera 4" also appears on every page in the header line.

Deviating descriptions for repairs on the Carrera 2 follow those of the Carrera 4. These repair descriptions for both models are separated by a yellow sheet.
"Carrera 2" appears on all pages in the header line after the separating sheet. The page number starts with 100 as an additional distinction.

	Page
Wiring	
Additional electrical equipment	97 - 01
Repairing wiring harness No. 2 and No. 3	97 - 03
Repairing wiring harness No. 173 (DME wiring harness)	97 - 07
Wiring diagram type 911 Carrera 4 model 89	97 - 1
Wiring diagram type 911 Carrera 2/4 model 90	97 - 33
Wiring diagram type 911 Carrera 2/4 model 91	97 - 71
Wiring diagram type 911 Carrera 2/4 model 92	97 - 109
Wiring diagram type 911 Carrera 2/4 model 93	97 - 149

Additional electrical equipment

Note

Additional electrical equipment must be connected only to the connection possibilities described below.

Terminal 30 not fused:

1. Screw terminals at feeder to central electrics
2. Connector A 11

Terminal X not fused: Connector A 14

Terminal 15 not fused: Connector A 22

Terminal 31

1. Connector A 23
2. Ground points VI
3. Ground point VII

Fusing possibilities

Note

Additional electrical equipment must be fused if the above connection possibilities can be used.

1. Fuse 26:

Incoming connector D 11

Outgoing connector C 45

2. Fuse 29:

Incoming connectors C 35 and D 15

Outgoing connector D 23

3. Separate fuses

Repairing wiring harness No. 2 and No. 3

Note

As of MY '93, the combination wires for ABS and BVA (brake pad wear monitor) are incorporated into the wiring harness. When repairing damaged wiring, the integral wirings may be cut off and replaced with repair wires.

Wiring harness No. 2 (passenger compartment) is already provided with the left and right rear wires.

Wiring harness No. 3 (trunk floor panel) includes the left and right front wires.

Run the following functional checks after the repair:

- ABS: Check with ABS tester.
- BVA (brake pad wear monitor): The warning lamp must go off when the engine is running and if the pads are o.k.

Connector joints

Rear

In the right-hand and left-hand seat well, before the wires branch off to the outside.

Front

In the right-hand and left-hand luggage compartment above the side member near the spring strut domes.

Rear

1. Disconnect battery.
2. Fold emergency seat backrests forward.
3. Remove rear wall trim.
4. Use adhesive tape to locate insulating padding out of the way.

Note

Unscrew convertible top motors (4 screws) on Cabriolet models.

5. Cut open insulating tube for wiring harness, starting at the rubber grommets and continuing for approx. 20 cm to the right.
6. Remove PVC insulating tape.
7. Remove shrink-fit caps from connector joints.
8. Cut off connectors.
9. Remove combination wires.
10. Fit repair wires, starting at wheel carriers and routing them towards the seat well.
11. Strip wire along a length of 10 mm.
12. Connect wires according to table using crimp connectors and standard crimping tool (A).

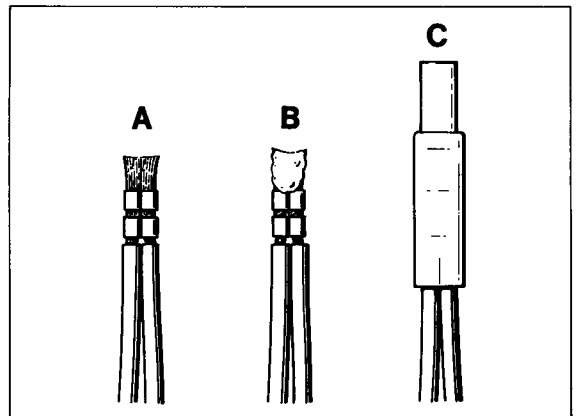

1316 - 97

Combination wire **Wiring harn. No. 2**

Color	Length	Color
		rear left
br/sw	30 mm	br/sw
br/gn	60 mm	br/gn
br/ws	90 mm	ws*
br/bl	120 mm	Screen
br	150 mm	br
		rear right
br/sw	30 mm	br/sw
br/gn	60 mm	br/gn
br/ws	90 mm	ge*
br/bl	120 mm	Screen
br	150 mm	br

* screened wires

br - brown
 sw - black
 ge - yellow
 bl - blue
 ws - white
 gn - green

13. Solder tips after crimping (B).
14. Fit shrink-fit caps and shrink them using a hot-air gun (C).
15. Wrap up entire connector joint area using commercially available PVC tape.

Front right

1. Disconnect battery.
2. Remove RH front wheel
3. Remove rear wheel housing liner.
4. Slacken tie-wrap in wheel housing area.
5. Slacken tie-wrap in luggage compartment.

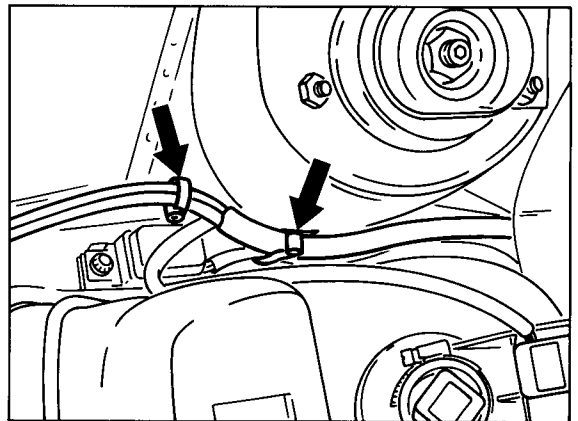

1372 - 97

6. Cut open insulating tube along wiring harness.
7. Remove PVC insulating tape.
8. Remove shrink-fit caps from connector joints.
9. Cut off connectors.
10. Remove combination wiring.
11. Fit repair wiring.
12. Strip wires along a length of 10 mm.

13. Connect wires according to table using crimp connectors and standard crimping tool (A).

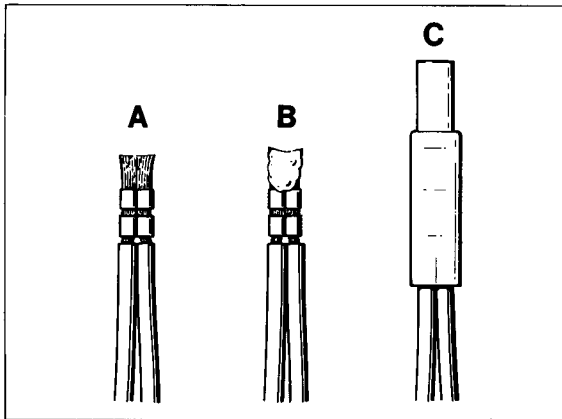

1316 - 97

Combination wire		Wiring harness No. 3
Color	Length	Color
		front right
br/sw	30 mm	br/sw
br/gn	60 mm	br/gn
br/ws	90 mm	gn*
br/bl	120 mm	Screen
br	150 mm	br

* screened wire

- br - brown
- sw - black
- bl - blue
- ws - white
- gn - green

14. Solder tips after crimping (B).
15. Fit shrink-fit caps and shrink them using a hot-air gun (C).

16. Wrap up entire connector joint area using commercially available PVC tape.

Front left

1. Disconnect battery.
2. Remove LH front wheel
3. Remove rear wheel housing liner.
4. Slacken tie-wrap in wheel housing area.
5. Remove bracket for brake fluid reservoir.

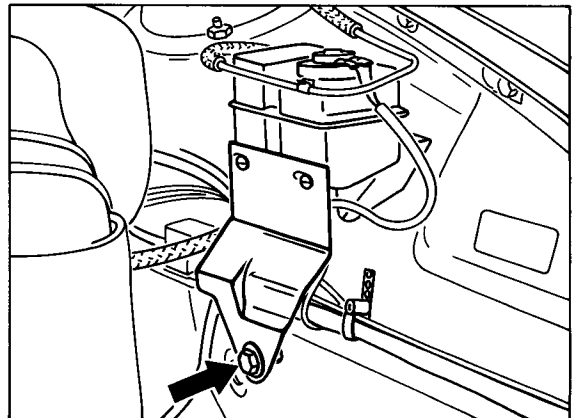

1373 - 97

6. Slacken tie-wrap in luggage compartment.

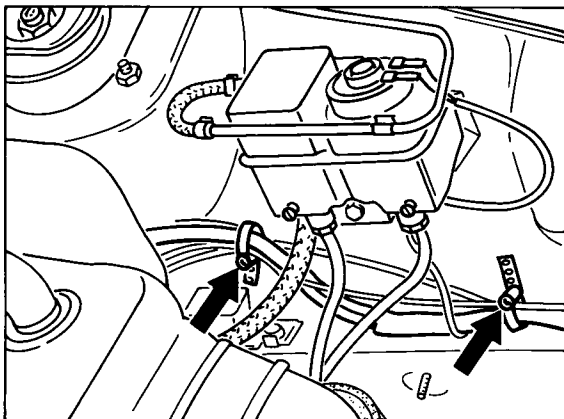

1374 - 97

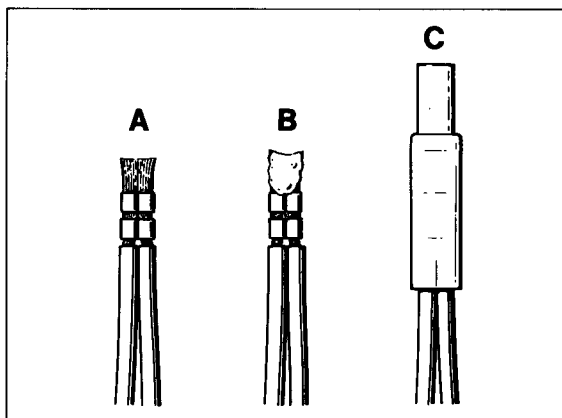

1316 - 97

7. Cut open insulating tube along wiring harness.

8. Remove PVC insulating tape.

9. Remove shrink caps from connector joints.

10. Cut off connectors.

11. Remove combination wire.

12. Fit repair wiring.

13. Strip wires along a length of 10 mm.

14. Connect wires according to table, using crimp connectors and standard crimping tool (A).

Combination wire

Wiring harn. No. 3

Color	Length	Color
		front left
br/sw	30 mm	br/sw
br/gn	60 mm	br/gn
br/ws	90 mm	rt*
br/bl	120 mm	Screen
br	150 mm	br

* screened wire

- br - brown
- sw - black
- rt - red
- bl - blue
- ws - white
- gn - green

15. Solder tips after crimping (B).

16. Put shrink-fit caps into place and shrink them using a hot-air gun (C).

17. Wrap up entire connector joint area using commercially available PVC tape.

Repairing wiring harness No. 173 (DME wiring harness)

Replacing air flow sensor connector

Situation: Rough engine running, e.g. poor throttle response, rough idling.

Note

Leave a gap of approx. 15 mm between the air flow sensor connector and the oil tank breather pipe. If the gap is too small or if the connector touches the breather pipe, check the breather pipe routing and correct it if required.

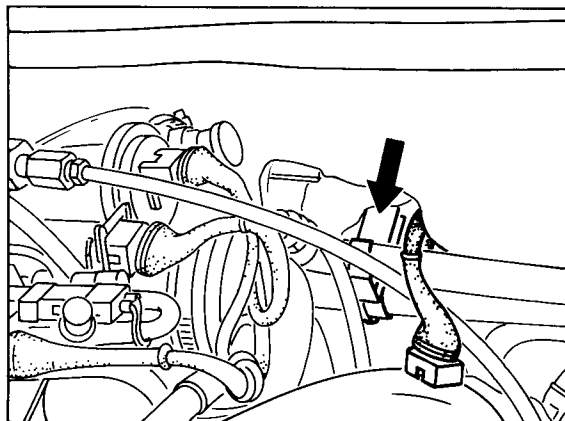

911 Carrera

1787-97

On the Speedster, the breather pipe bracket is located to the right of the air flow sensor wire while, on the 911 Carrera, it is located to the left.

1. Remove upper air filter section with filter element.
2. Release oil tank breather hose from rubber shroud.

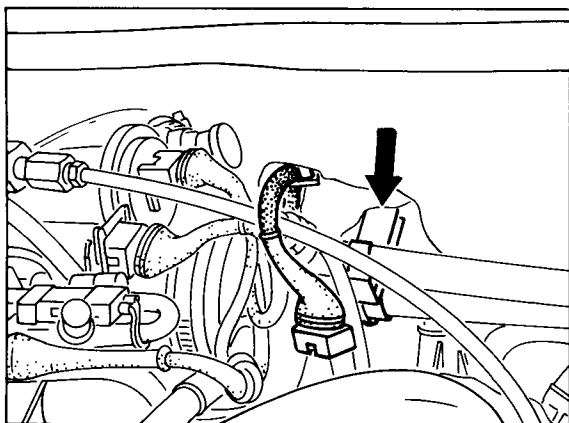

Speedster

1786-97

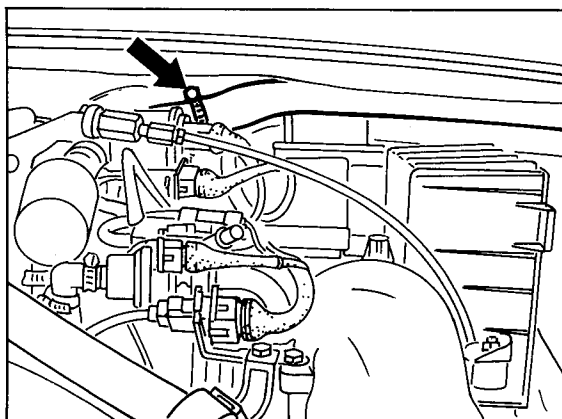

1788-97

3. Pull connector off the air flow sensor. The connector is accessible from the right-hand side across the air filter.

4. Pull out wiring harness complete with connector from between air flow sensor and idle speed positioner towards the rear.
5. Push back rubber sleeve.

Note

If the vehicle is fitted with a rubber sleeve with straight wire exit, fit angled rubber sleeve (wire exits towards left) from the repair kit.

6. Cut off wires close to the connector housing.

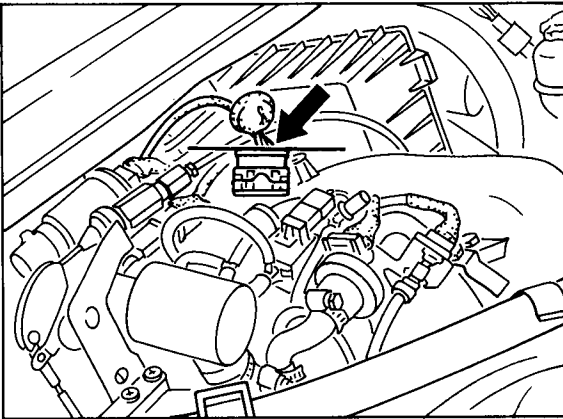

1789-97

7. Strip wires along a length of approx. 5 mm.
8. Crimp connector contacts from repair kit with a crimping tool, e.g. VAG 000.097.003 A.
9. Connect wires to connector housing according to wiring diagram or the below table.
 - 1 - blue/grey
 - 2 - green/red
 - 3 - blue/green
 - 4 - green/black
 - 5 - not used

Wiring Diagram Type 911 Carrera 4 Model 89

The wiring diagram consists of *11 individual wiring diagrams*, 1 sheet *construction components* and 1 sheet *plug connections and ground points*. These are divided into coordinate fields.

Each individual wiring diagram contains a part of the central-electrics box in a dashdotted frame.

This part of the central-electrics box shows all the lines and relays necessary for the individual wiring diagram.

The earth/ground points are identified by "MP" and their location is shown in a vehicle diagram.

The 10-pin connectors on the central-electrics box are clipped together out of 3 parts, the 20-pin connectors are clipped together out of 5 parts.

Part 1, with the moduled-on fastening lug, is the "starting element".

Parts 2,3 and 4 are "module elements".

The 10-pin connectors only contents one "module element".

Start- and module elements are identified by the numbers 1.....5.

Part 5 ist a "coding element".

The designations of the plug connections in the wiring diagram refer to the "starting element" from, for example, B 11.....15, and to the first module element from B 21.....25.

Wiring Diagram Type 911 Carrera 4 Model 89

	Coordinates	
Sheet 1	1 - 10	Lights
Sheet 2	11 - 20	Alarm System, Central Locks, Mirror, Power Window Regulator
Sheet 3	21 - 30	Heater, AC, Coolant Fan, Rear Window Defogger
Sheet 4	31 - 40	ABS, Porsche Dynamic AWD Control
Sheet 5	41 - 50	Motor, Ignition, Cruise Control
Sheet 6	51 - 60	Instruments, Sender, Central Informer
Sheet 7	61 - 70	Seats
Sheet 8	71 - 80	Rear Spoiler, Two-Tone Horns, Wipe- and Wash Cleaners
Sheet 9	81 - 90	Radio
Sheet 10	91 - 100	Fog Light, Rear Fog Light
Sheet 11		Central Electric
Sheet 12		Construction Components
Sheet 13		Plug Connections and Ground Points

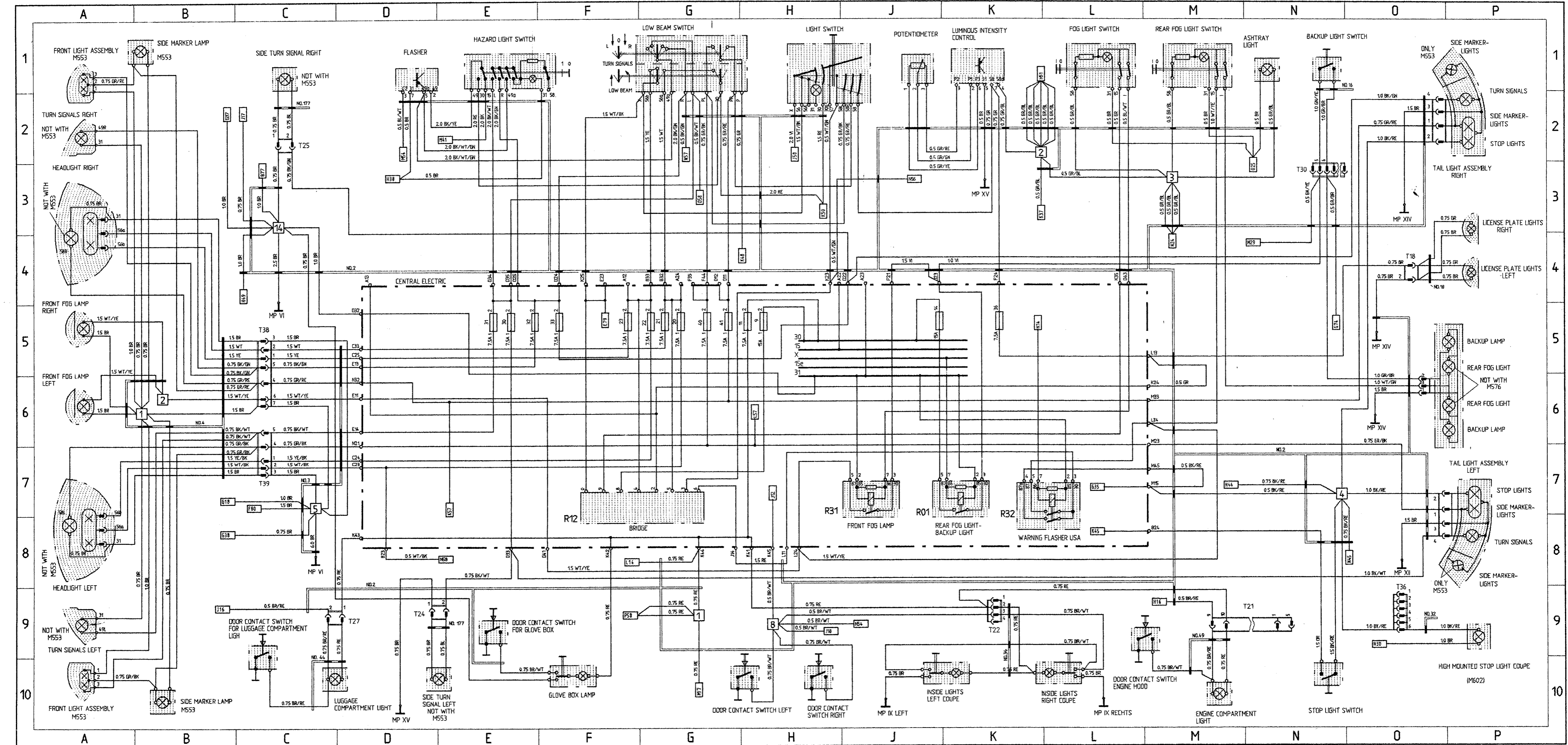

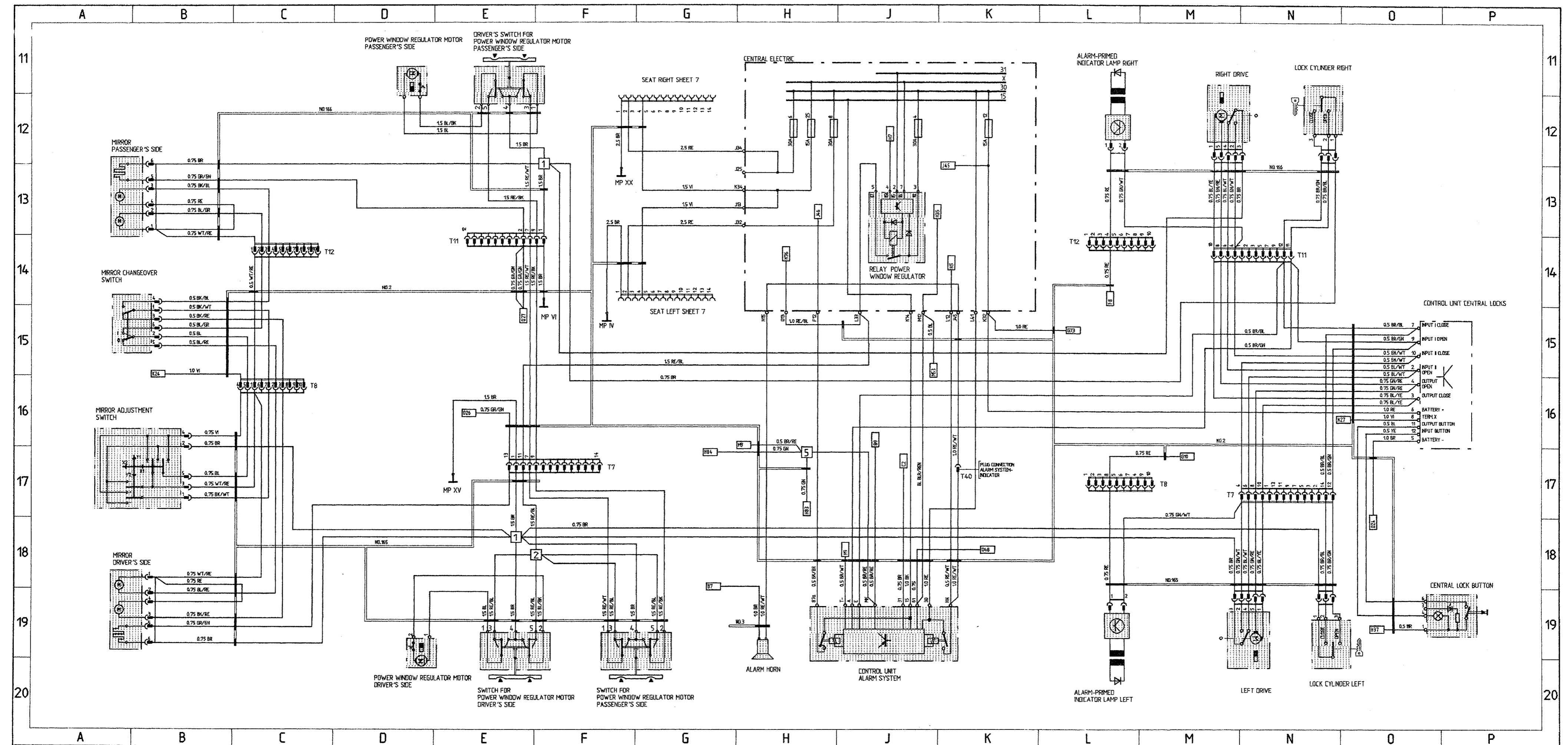

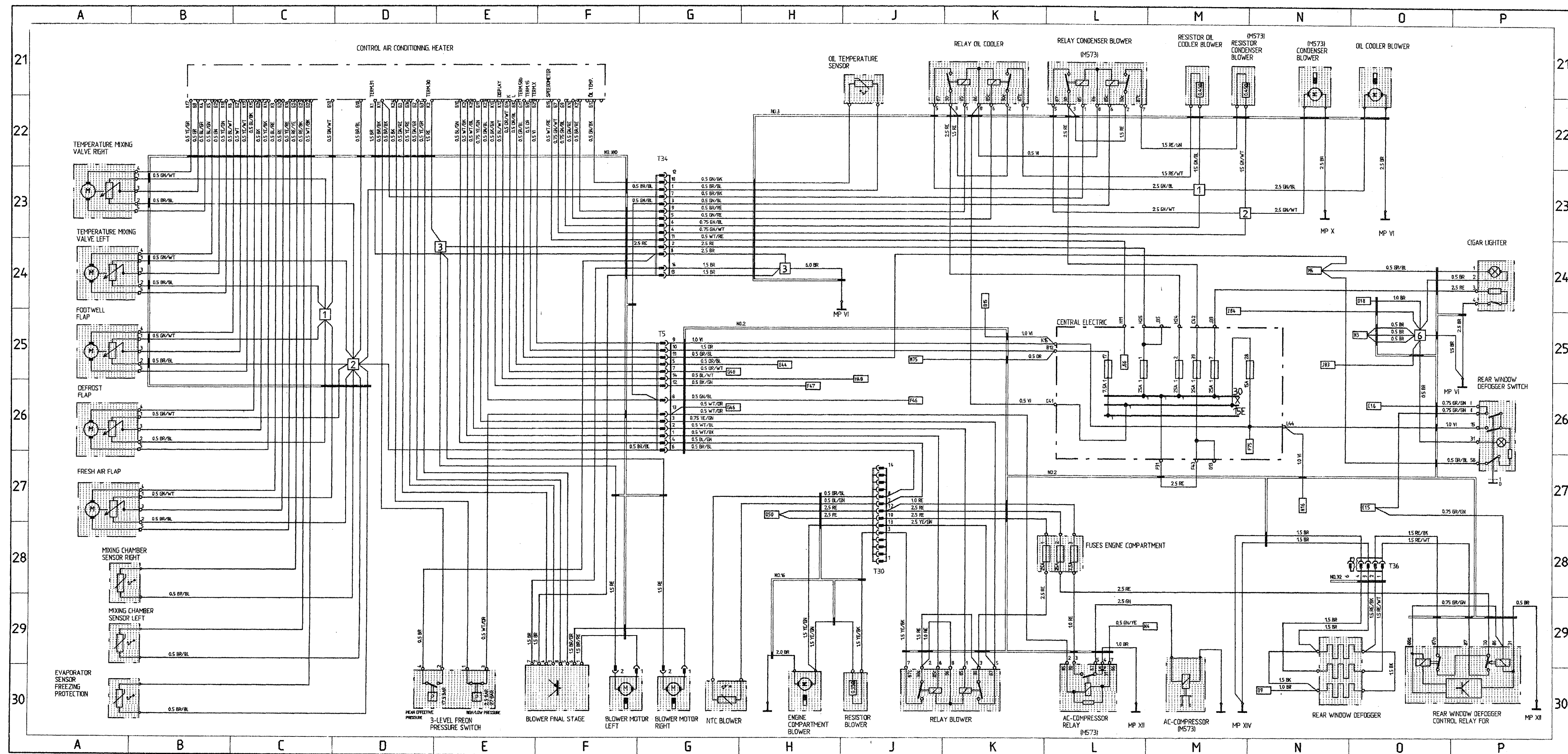

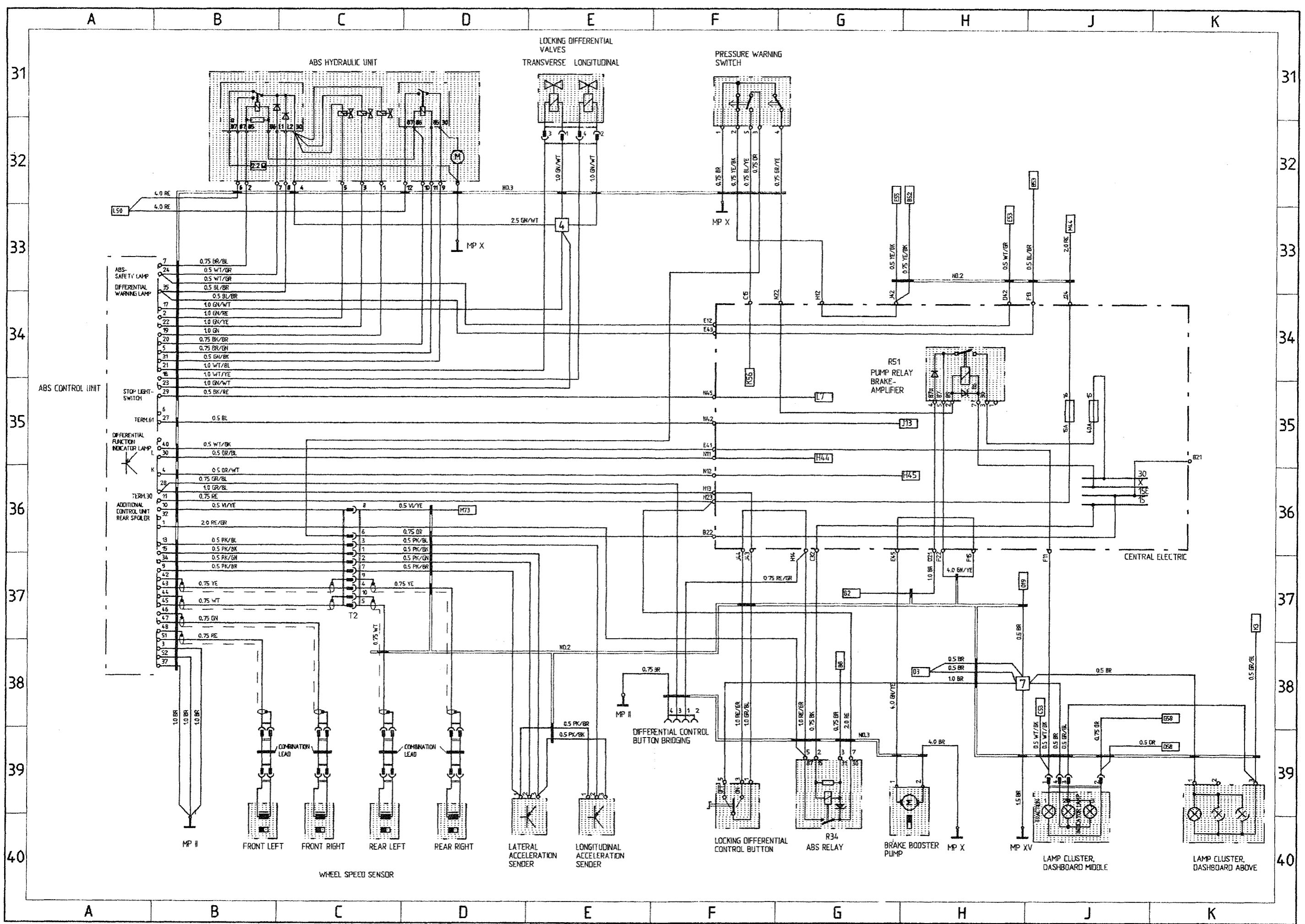

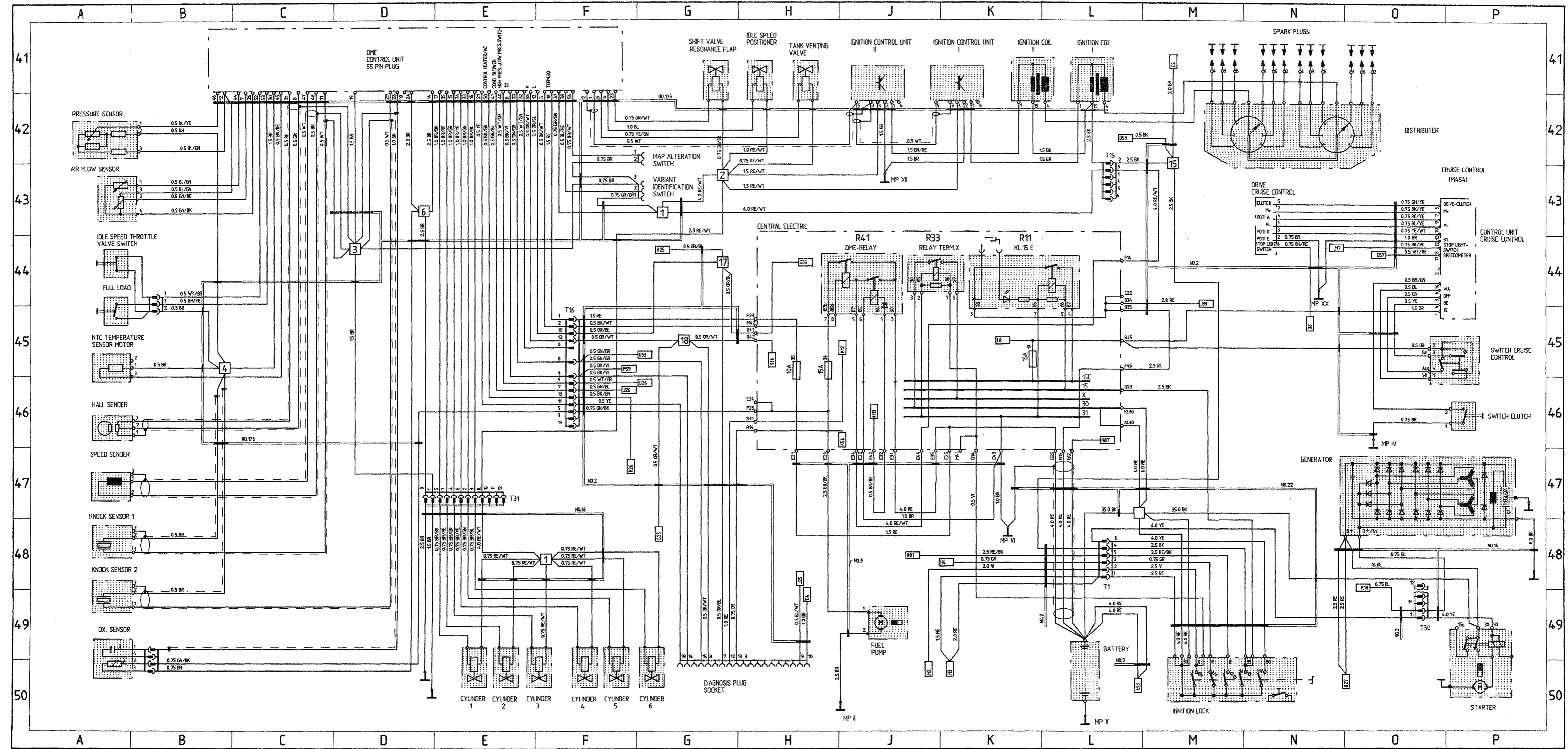

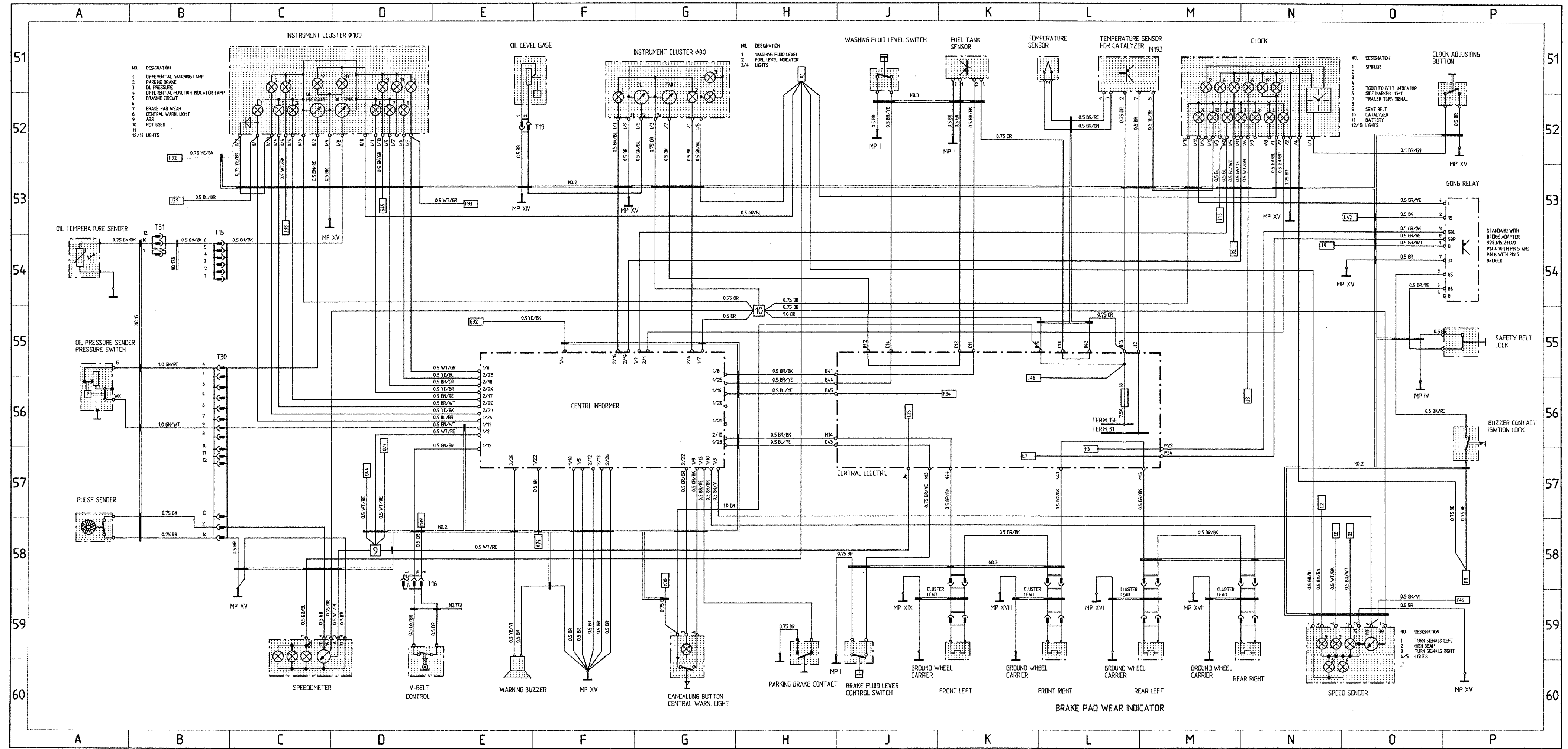

SEATS

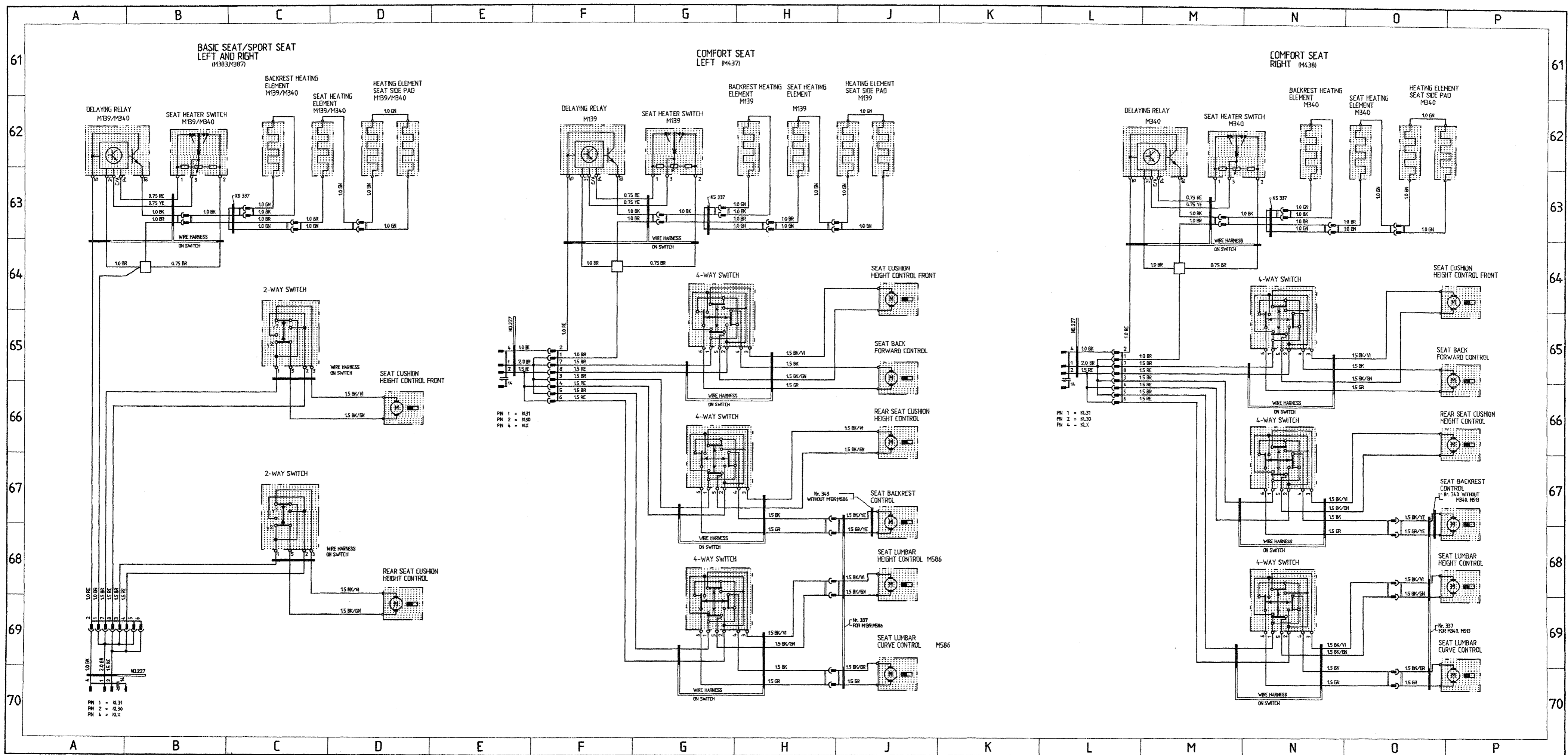

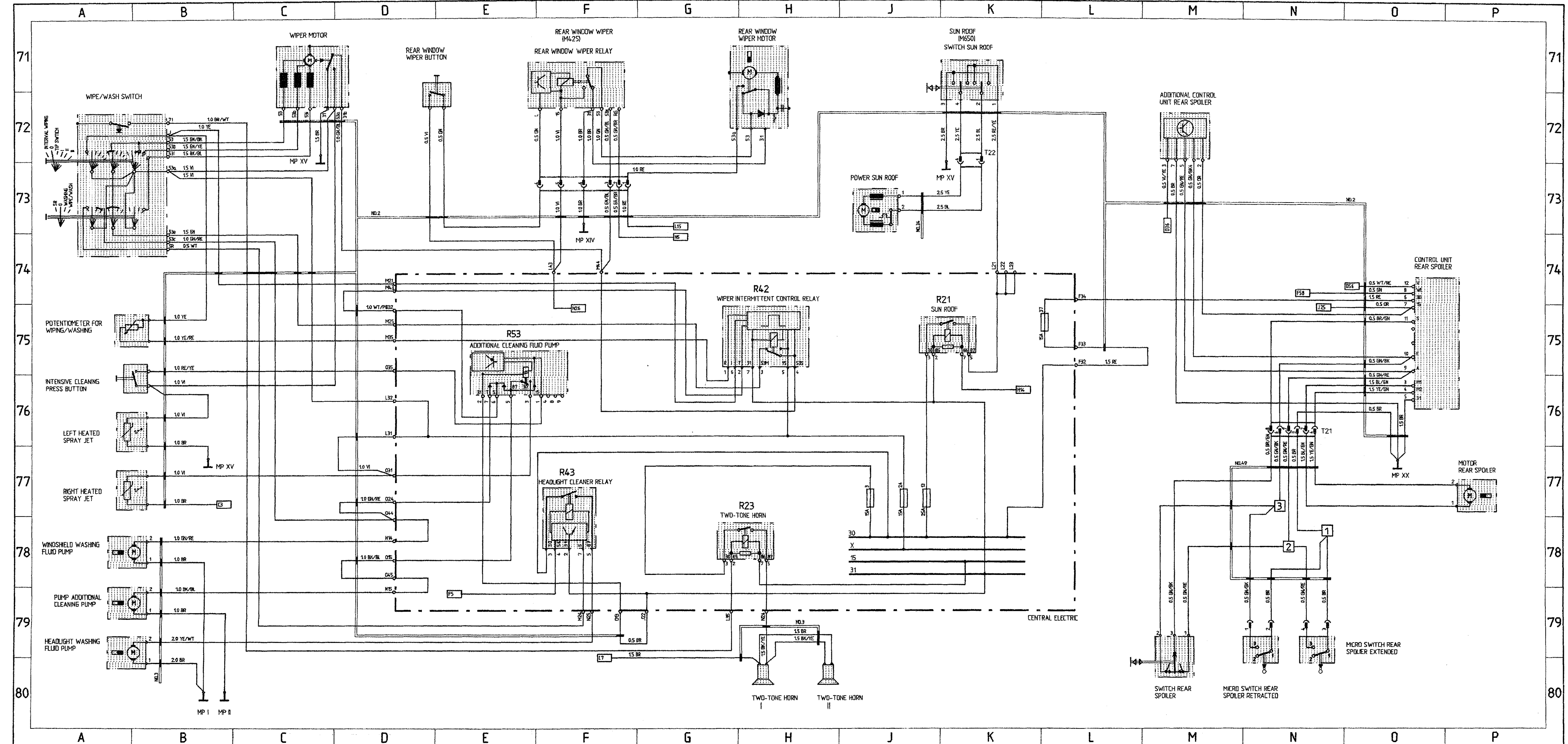

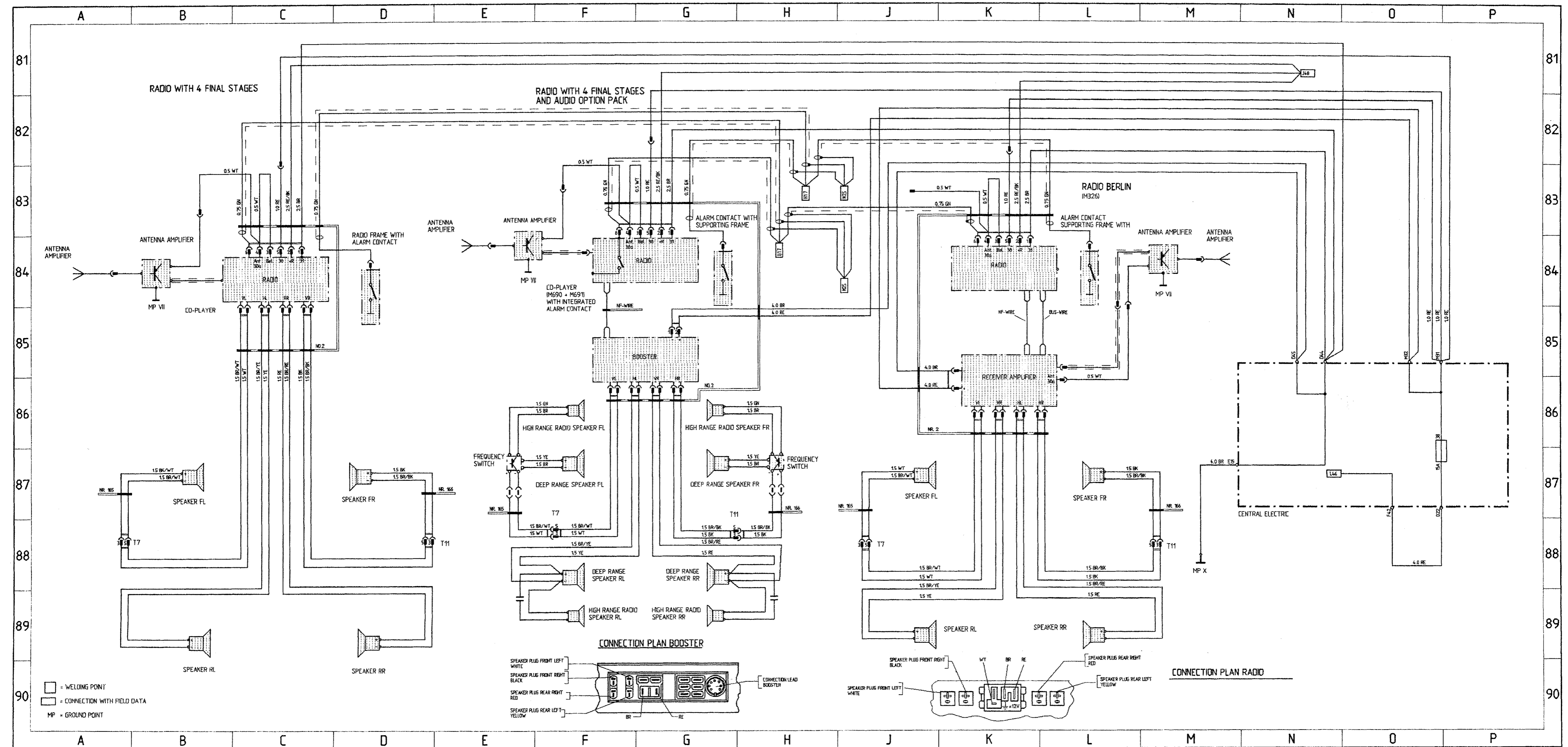

FOG LIGHT - AND REAR FOG LIGHT - GEARSHIFT MECHANISM

ROW
 FOG LIGHT +
 REAR FOG LIGHT FROM 58

M487-NORWAY
 FOG LIGHT + REAR FOG LIGHT
 ONLY WITH 57

M553/M193-USA/JAPAN
 FOG LIGHT WITH 56b + 57

M061-ENGLAND
 FOG LIGHT +
 REAR FOG LIGHT FROM 58

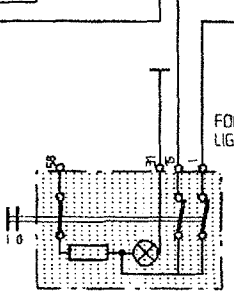
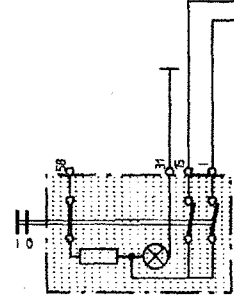
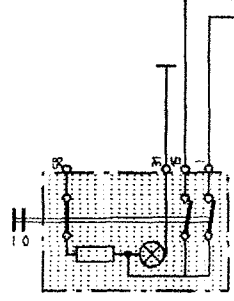
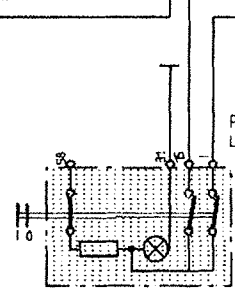
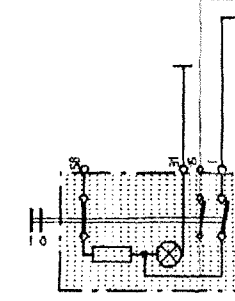
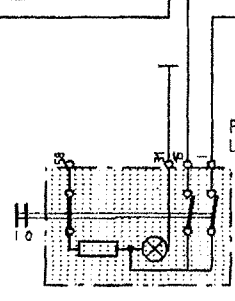
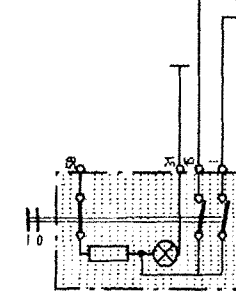
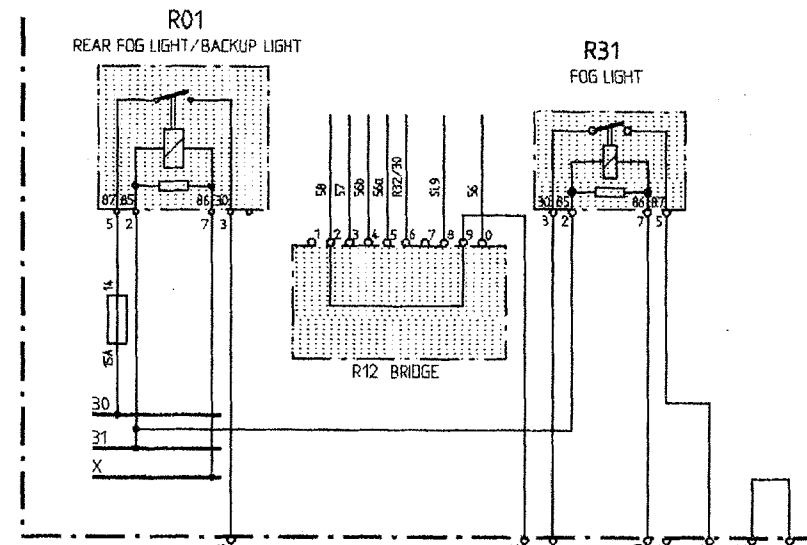
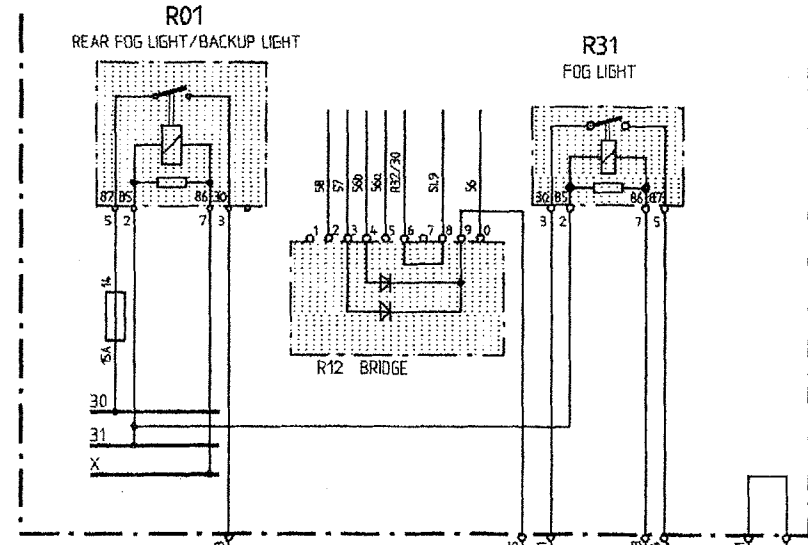
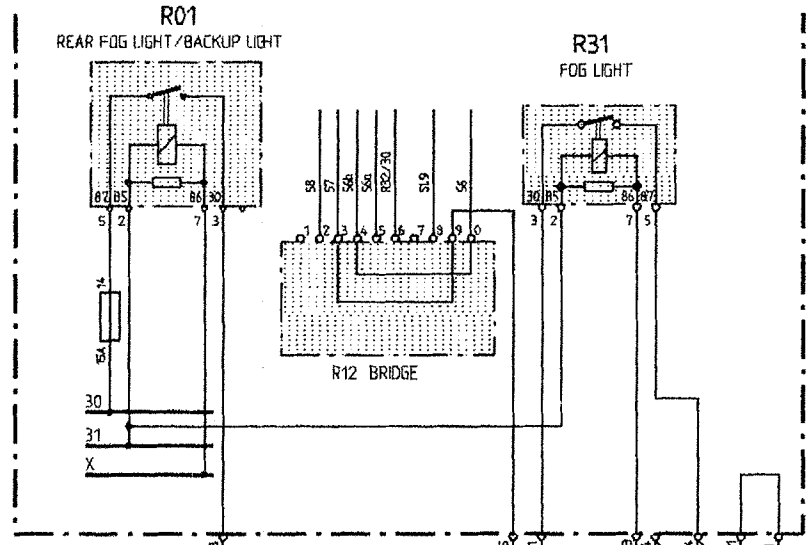
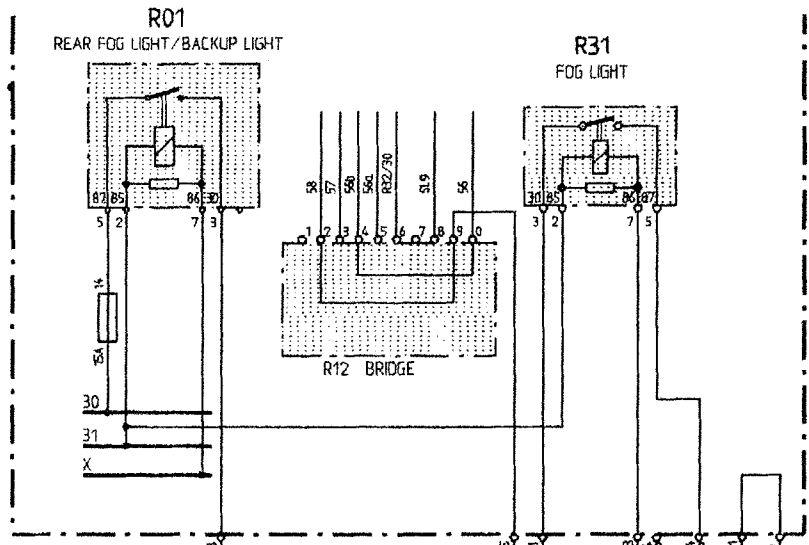

FOG LIGHT SWITCH

REAR FOG LIGHT SWITCH

FOG LIGHT SWITCH

REAR FOG LIGHT SWITCH

FOG LIGHT SWITCH

FOG LIGHT SWITCH

REAR FOG LIGHT SWITCH

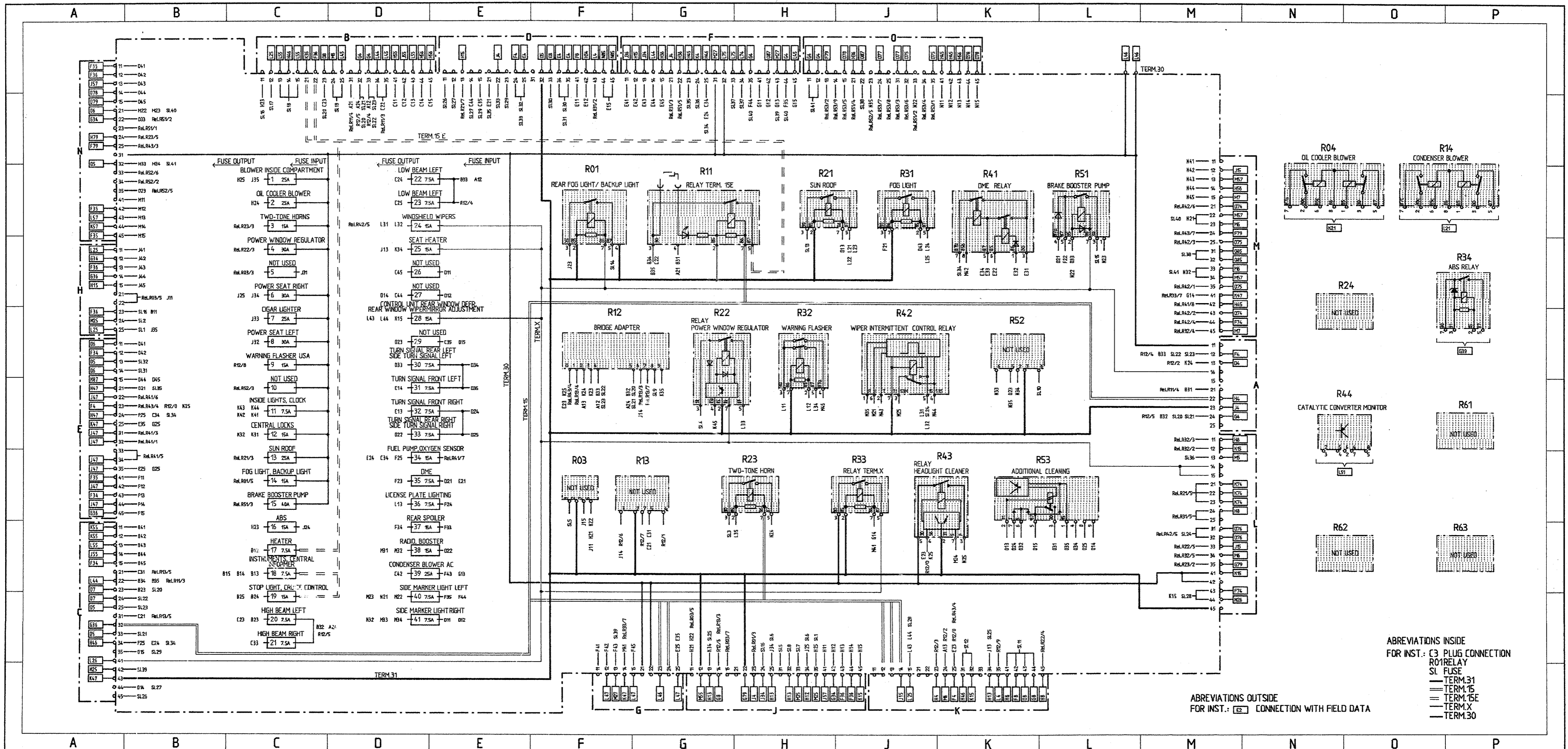

ABBREVIATIONS INSIDE
FOR INST.: C3 PLUG CONNECTION
R01 RELAY
SI FUSE
TERM.31
TERM.15
TERM.15E
TERM.X
TERM.30

ABBREVIATIONS OUTSIDE
FOR INST.: [Symbol] CONNECTION WITH FIELD DATA

CONSTRUCTION COMPONENTS

CONSTRUCTION COMPONENTS

DESIGNATION, FUNCTION	POSITION IN VEHICLE	NOTE	FIELD IN WIRE DIAGRAM
ABS RELAY	6cM	CENTRAL ELECTRIC	G39/40
ALARM HORN	3cL	IN WHEEL HOUSING FRONT RIGHT	H19
ANTENNA AMPLIFIER	7bL	IN LUGGAGE COMPARTMENT	B84,E84,M84
FLASHER BOOSTER	7dN	IN CENTRE CONSOLE	D1
DIAGNOSIS PLUG SOCKET	9eM	UNDER THE SEAT RIGHT	G85
DME RELAY	7cL	IN PASSENGER'S FOOTWELL	G/H50
DME CONTROL UNIT	6cM	CENTRAL ELECTRIC	J44
SPEED SENDER	9eP	UNDER THE SEAT LEFT	B-F41
THROTTLE VALVE SWITCH	15cP	ON ENGINE LEFT	A47
PRESSURE SENSOR	15dN	ON THROTTLE VALVE ASSEMBLY	A44/45
PRESSURE WARNING SWITCH	10eP	UNDER THE SEAT LEFT	A42
PRESSURE SWITCH AIR CONDITIONING SYSTEM	1dD	IN LUGGAGE COMPARTMENT	F31
RECEIVER FOR RADIO BERLIN	6bD	IN LUGGAGE COMPARTMENT	E30
TWO-TONE HORN	9eM	UNDER THE SEAT RIGHT	K86
FREQUENCY SWITCH FRONT LEFT	3cL	IN WHEEL HOUSING FRONT RIGHT	H80
FREQUENCY SWITCH FRONT RIGHT	3cL	IN WHEEL HOUSING FRONT RIGHT	H80
BLOWER FINAL STAGE	9dQ	UNDER THE DOOR TRIM PANEL	E87
BLOWER MOTOR RIGHT	9dL	UNDER THE DOOR TRIM PANEL	H87
BLOWER MOTOR LEFT	6dM	IN LUGGAGE COMPARTMENT	F30
GONG RELAY	6cM	IN LUGGAGE COMPARTMENT	F30
HALL SENDER	6cP	IN LUGGAGE COMPARTMENT	F30
SWITCH REAR SPOILER	6cP	ON STEERING COLUMN LEFT	P53/54
REAR WINDOW WIPER RELAY	17cD	ON DISTRIBUTOR	A46
HYDRAULIC UNIT ABS	17cD	ON TAILGATE	M79
PULSE SENDER	15bD	ON REAR WINDOW WIPER MOTOR	F71
MAP ALTERATION-SWITCH	3dP	IN LUGGAGE COMPARTMENT	C32
KNOCK SENSOR1	13dD	ON GEARBOX	A58
KNOCK SENSOR2	9eP	UNDER THE SEAT LEFT	G42
CONDENSER BLOWER	15cP	ON ENGINE LEFT	A48
FUEL PUMP	16cN	ON ENGINE ABOVE	A49
LOCKING DIFFERENTIAL VALVES, LONGITUDINAL	2dQ	IN WHEEL HOUSING FRONT LEFT	N21
IDLE SPEED POSITIONER	6eM	BEHIND THE BASE	J49
MICRO SWITCH REAR SPOILER EXTENDED	3dM	IN LUGGAGE COMPARTMENT	E31
MICRO SWITCH REAR SPOILER RETRACTED	15bN	ENGINE COMPARTMENT	H41
MOTOR SUN ROOF	16bP	ON TAILGATE	N79
NTC HEATER FAN	16bP	ON TAILGATE	N79
OIL PRESSURE SENDER	12dN	IN ROOF	J73
OIL PRESSURE SWITCH	16cP	ENGINE COMPARTMENT	G30
OIL COOLER BLOWER	14cN	ON ENGINE	A55/56
OIL LEVEL GAGE	14cN	ON ENGINE	A55/56
OIL TEMPERATURE SENDER	2dL	IN WHEEL HOUSING FRONT RIGHT	D21
BRAKE BOOSTER PUMP	12cK	IN WHEEL HOUSING REAR RIGHT	E/F51/52
LOCKING DIFFERENTIAL VALVES, TRANSVERSE	14cN	ON ENGINE	A54
	1dD	IN LUGGAGE COMPARTMENT	H39/40
	3dM	IN LUGGAGE COMPARTMENT	E31

DESIGNATION, FUNCTION	POSITION IN VEHICLE	NOTE	FIELD IN WIRE DIAGRAM
CONTROL RELAY REAR WINDOW DEFOGGER	16cP	CARRIER PLATE IN ENGINE COMPARTMENT	O/P29/30
RELAY CONDENSER BLOWER	6cM	CENTRAL ELECTRIC	L21
RELAY AC COMPRESSOR	16cP	CARRIER PLATE IN ENGINE COMPARTMENT	L30
RELAY ALARM SYSTEM USA	6cM	CENTRAL ELECTRIC	K/L7
RELAY TWO-TONE HORN	6cM	CENTRAL ELECTRIC	G/H78
RELAY POWER WINDOW REGULATOR	6cM	CENTRAL ELECTRIC	J13/14
RELAY BLOWER	16cP	CARRIER PLATE IN ENGINE COMPARTMENT	J/K30
RELAY ADDITIONAL CLEANING FLUID PUMP	6cM	CENTRAL ELECTRIC	E75/76
RELAY CATALYZER	6cM	CENTRAL ELECTRIC	L/M51
RELAY TERM.X	6cM	CENTRAL ELECTRIC	K44
RELAY TERM 15 E	6cM	CENTRAL ELECTRIC	K/L44
RELAY REAR FOG LIGHT- BACKUP LIGHT	6cM	CENTRAL ELECTRIC	J/K7
RELAY FRONT FOG LAMP	6cM	CENTRAL ELECTRIC	J7
RELAY OIL COOLER BLOWER	6cM	CENTRAL ELECTRIC	K21
RELAY BRAKE BOOSTER PUMP	6cM	CENTRAL ELECTRIC	H34/35
RELAY SUN ROOF	6cM	CENTRAL ELECTRIC	J/K75
BACKUP LIGHT SWITCH	14dN	ON GEARBOX RIGHT	M1
SHIFT VALVE RESONANCE FLAP	15bN	ON ENGINE	G41
WINDSHIELD WASHING FLUID PUMP	3cD	ON WINDSHIELD WASHER TANK IN WHEEL HOUSING FRONT LEFT	A78
FUSES ENGINE COMPARTMENT	16cP	CARRIER PLATE IN ENGINE COMPARTMENT	L28
HEADLIGHT CLEANER PUMP	3cQ	ON WINDSHIELD WASHER TANK IN WHEEL HOUSING FRONT LEFT	A79/80
HEADLIGHT CLEANER RELAY	6cM	CENTRAL ELECTRIC	F77/78
STARTER	14dN	ON CLUTCH BELL HOUSING RIGHT	P49/50
DRIVE CRUISE CONTROL	15cD	ON ENGINE	N43/44
CONTROL UNIT ABS	2dM	IN LUGGAGE COMPARTMENT	A33-38
CONTROL UNIT ALARM SYSTEM	7bL	IN LUGGAGE COMPARTMENT	J19
CONTROL UNIT INSTRUMENT LIGHTS	7bQ	IN LUGGAGE COMPARTMENT LEFT	K1
CONTROL UNIT REAR SPOILER	9eN	UNDER THE SEAT RIGHT	D74-76
CONTROL UNIT HEATER, AIR CONDITIONER	7cD	ON INSTRUMENT PANEL	B-F21
CONTROL UNIT CRUISE CONTROL	9eN	UNDER THE SEAT RIGHT	P43/44
CONTROL UNIT CENTRAL LOCKS	6cN	UNDER THE INSTRUMENT PANEL	P15/16
BUZZER CONTACT	7cP	ON IGNITION LOCK	P56
FUEL LEVEL SENDER	5cM	IN FUEL TANK	K51
TANK VENTING VALVE	15cN	ON ENGINE ABOVE	H41
TEMPERATURE MOTOR	15cP	ON ENGINE LEFT	A45
VARIANT IDENTIFICATION SWITCH	9eP	UNDER THE SEAT LEFT	G43
RESISTOR BLOWER	16dP	ENGINE COMPARTMENT	J30
RESISTOR CONDENSER BLOWER	2dQ	IN WHEEL HOUSING FRONT LEFT	M21
RESISTOR OIL COOLER BLOWER	2dL	IN WHEEL HOUSING FRONT RIGHT	M21
WARNING BUZZER	7cP	ON INSTRUMENT PANEL	E60
WIPER INTERMITTENT CONTROL RELAY	6cM	CENTRAL ELECTRIC	H75
CENTRAL ELECTRIC	6cM	IN LUGGAGE COMPARTMENT	---
CENTRAL INFORMER	6cP	ON STEERING COLUMN LEFT	F56
IGNITION CONTROL UNIT I	15cP	ENGINE COMPARTMENT LEFT	K41
IGNITION CONTROL UNIT II	15cP	ENGINE COMPARTMENT LEFT	J41
IGNITION COIL I	15cQ	ENGINE COMPARTMENT LEFT	L41
IGNITION COIL II	15cQ	ENGINE COMPARTMENT LEFT	K41
ADDITIONAL CLEANING FLUID PUMP	4cM	IN LUGGAGE COMPARTMENT	A79

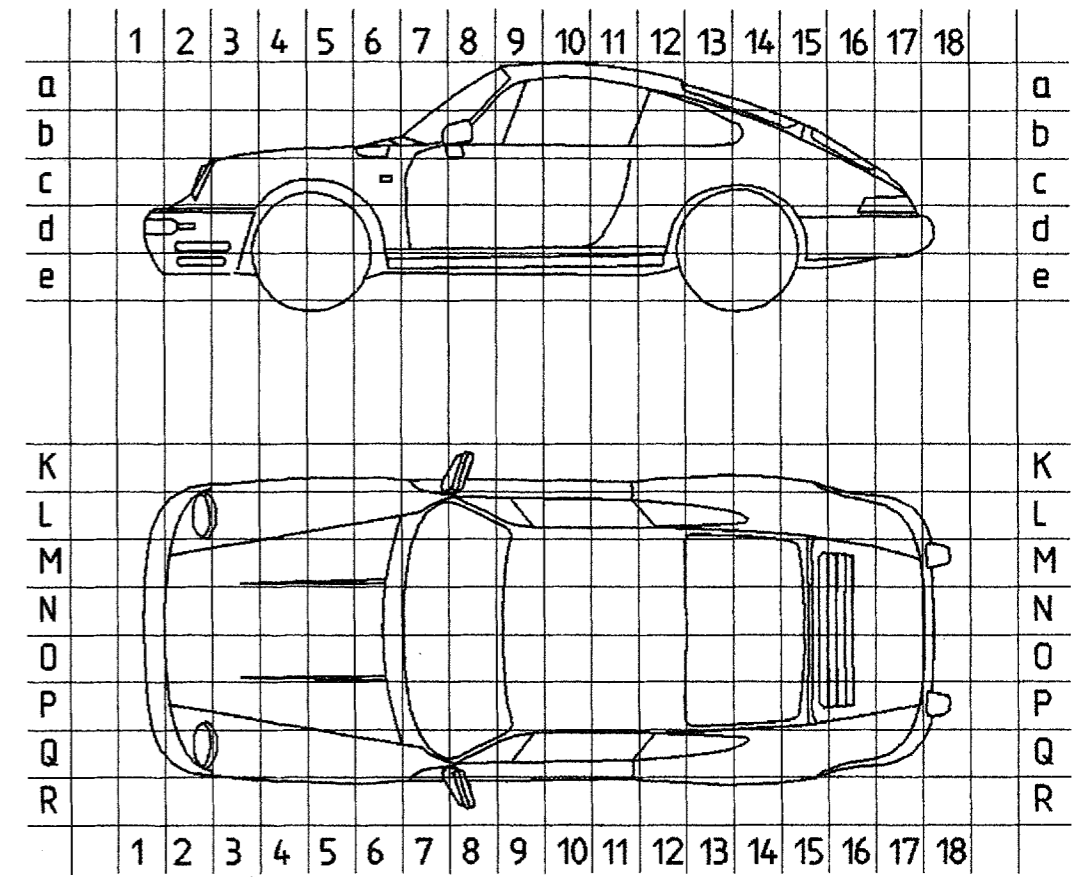

PLUG CONNECTIONS AND GROUND POINTS

A	B	C	D	E	F	G	H	J	K	L	M	N	O	P
---	---	---	---	---	---	---	---	---	---	---	---	---	---	---

PLUG CONNECTIONS

CODE	NUMBER OF PINS	DESIGNATION, FUNCTION	POSITION IN VEHICLE LHD	NOTE	FIELD
T1	6	IGNITION LOCK	6cP	ON STEERING COLUMN LEFT	L48
T2	10	ABS	6cL	IN LUGGAGE COMPARTMENT RIGHT	C36/37
T5	14	HEATER, AIR CONDITIONER	6cM	UNDER THE INSTRUMENT PANEL RIGHT	G25/26
T7	14	DOOR DRIVER'S SIDE	6cQ	UNDER THE INSTRUMENT PANEL LEFT	N17,A88,F88,J88
T8	10	DOOR DRIVER'S SIDE	6cQ	UNDER THE INSTRUMENT PANEL LEFT	C16,E/F17,L17
T11	12	DOOR PASSENGER'S SIDE	6cL	UNDER THE INSTRUMENT PANEL RIGHT	E14,M/N14,D88,H88,M88
T12	10	DOOR PASSENGER'S SIDE	6cL	UNDER THE INSTRUMENT PANEL RIGHT	C14,L/M14
T15	6	DME	9eP	UNDER THE SEAT LEFT	L43/B54
T16	14	DME	9eP	UNDER THE SEAT LEFT	F45/46,D58
T18	2	LICENSE PLATE LIGHTS	17dL	TAIL LIGHTS RIGHT	D4
T19	2	OIL LEVEL GAGE	15cM	ENGINE COMPARTMENT RIGHT	E52
T21	10	TAILGATE	15cL	ENGINE COMPARTMENT RIGHT	M/N9,N76
T22	4	INSIDE LIGHTS, SUN ROOF	15dM	BELOW THE PARCEL TRAY	K9,K72
T24	2	SIDE TURN SIGNAL LEFT	7bQ	IN LUGGAGE AT THE LONGITUDINAL SUPPORT LEFT	D/E9
T25	2	SIDE TURN SIGNAL RIGHT	7bL	IN LUGGAGE AT THE LONGITUDINAL SUPPORT RIGHT	C2
T27	2	LUGGAGE COMPARTMENT LIGHT	7bL	IN LUGGAGE AT THE LONGITUDINAL SUPPORT RIGHT	C/D9
T30	14	NO. 16 MOTOR	16cP	CARRIER PLATE IN ENGINE COMPARTMENT	N/D3,J27/28,048/49,B55-58
T31	12	MOTOR, DME	16cP	CARRIER PLATE IN ENGINE COMPARTMENT	D/E47,B54
T34	14	HEATER, AIR CONDITIONER	6cM	IN LUGGAGE COMPARTMENT RIGHT	G23/24
T36	6	REAR WINDOW	15dM	BELOW THE PARCEL TRAY	D9,D28
T38	7	NO.4, FRONT LIGHTS	3cL	IN WHEEL HOUSING FRONT RIGHT	E5/6
T39	5	NO.4, FRONT LIGHTS	3cL	IN WHEEL HOUSING FRONT RIGHT	C6/7
T40	1	ALARM SYSTEM INDICATOR	7bL	IN LUGGAGE COMPARTMENT	K17

M - NUMBERS

M 139	ADJUSTABLE SEAT HEATING SEAT LEFT
M 193	JAPAN VERSION
M 326	RADIO BERLIN
M 340	ADJUSTABLE SEAT HEATING SEAT RIGHT
M 383	SPORT SEAT LEFT HEIGHT ELECTR. ADJUSTABLE
M 387	SPORT SEAT RIGHT HEIGHT ELECTR. ADJUSTABLE
M 425	REAR WINDOW WIPER
M 437	COMFORT SEAT LEFT
M 438	COMFORT SEAT RIGHT
M 454	CRUISE CONTROL
M 513	LUMBAR SUPPORT SEAT RIGHT
M 553	USA - CANADA VERSION
M 573	RELAY CONDENSER BLOWER
M 576	WITHOUT REAR FOG LIGHT
M 586	LUMBAR SUPPORT SEAT LEFT
M 602	HIGH MOUNTED STOP LIGHT
M 650	SUN ROOF

GROUND POINTS

CODE	NOTE	POSITION IN VEHICLE LHD
MP I	LUGGAGE COMPARTMENT, WHEEL HOUSING LEFT	2cP
MP II	LUGGAGE COMPARTMENT, WHEEL HOUSING RIGHT	2cM
MP III	ON FIREWALL	---
MP IV	GROUND OF POWER CONSUMERS UNDER THE SEAT LEFT	11eP
MP V	ELECTRONIC UNDER THE SEAT LEFT	10eP
MP VI	CENTRAL ELECTRIC ON LONGITUDINAL SUPPORT RIGHT	6dL
MP VII	ANTENNA AMPLIFIER ON LONGITUDINAL SUPPORT RIGHT	7bL
MP VIII	INSIDE LIGHTS CONVERTIBLE ROOF, CENTER, FRONT	9aM
MP IX	INSIDE LIGHTS ROOF RIGHT	11dL
MP IX	INSIDE LIGHTS ROOF LEFT	11dP
MP X	BATTERY LUGGAGE COMPARTMENT LEFT	3eP
MP XI	GROUND STRAP STARTER TRANSMISSION MOTOR BODY	14cM
MP XII	ENGINE COMPARTMENT REAR LEFT	15cQ
MP XIII	MOTOR LEFT	15cO
MP XIV	ENGINE COMPARTM. REAR RIGHT	15cL
MP XV	INSTRUMENT LONGITUDINAL SUPPORT LEFT	7bQ
MP XVI	COMBINATION LEAD REAR LEFT	13dP
MP XVII	COMBINATION LEAD REAR RIGHT	12dM
MP XVIII	COMBINATION LEAD FRONT RIGHT	4cM
MP XIX	COMBINATION LEAD FRONT LEFT	4cP
MP XX	SEAT CROSS MEMBER UNDER THE SEAT RIGHT	8eL

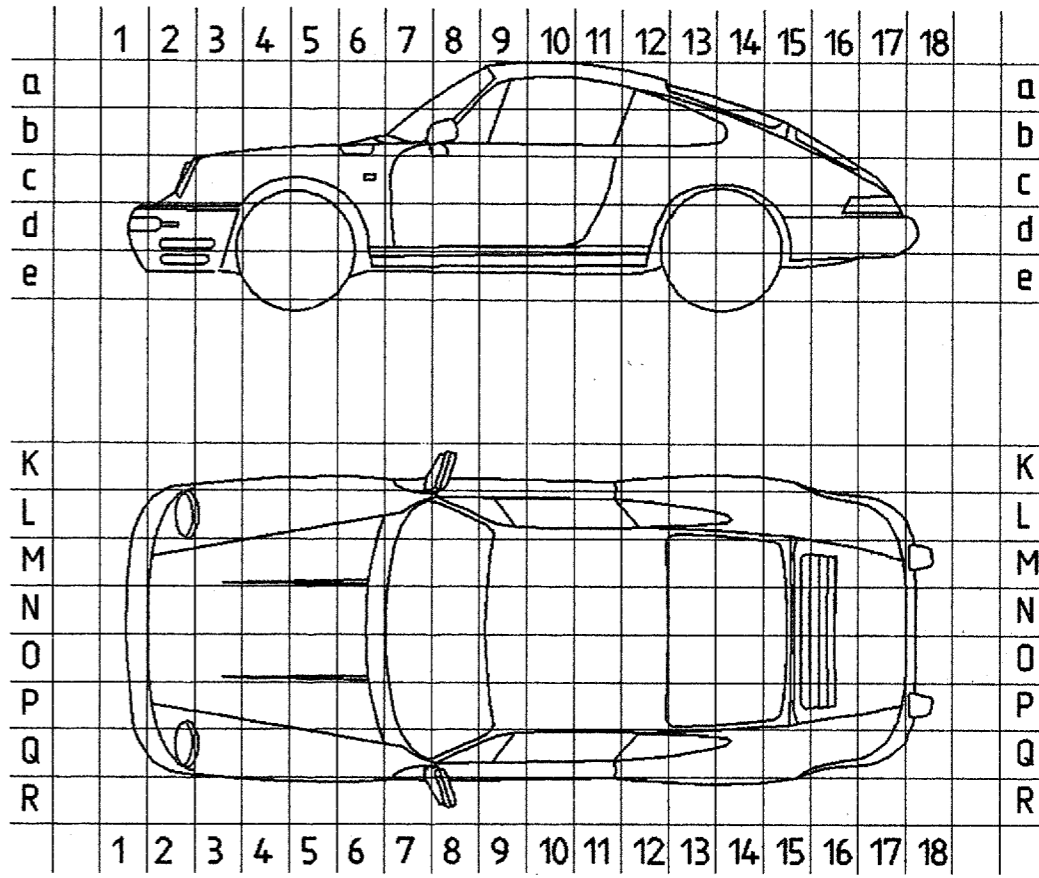

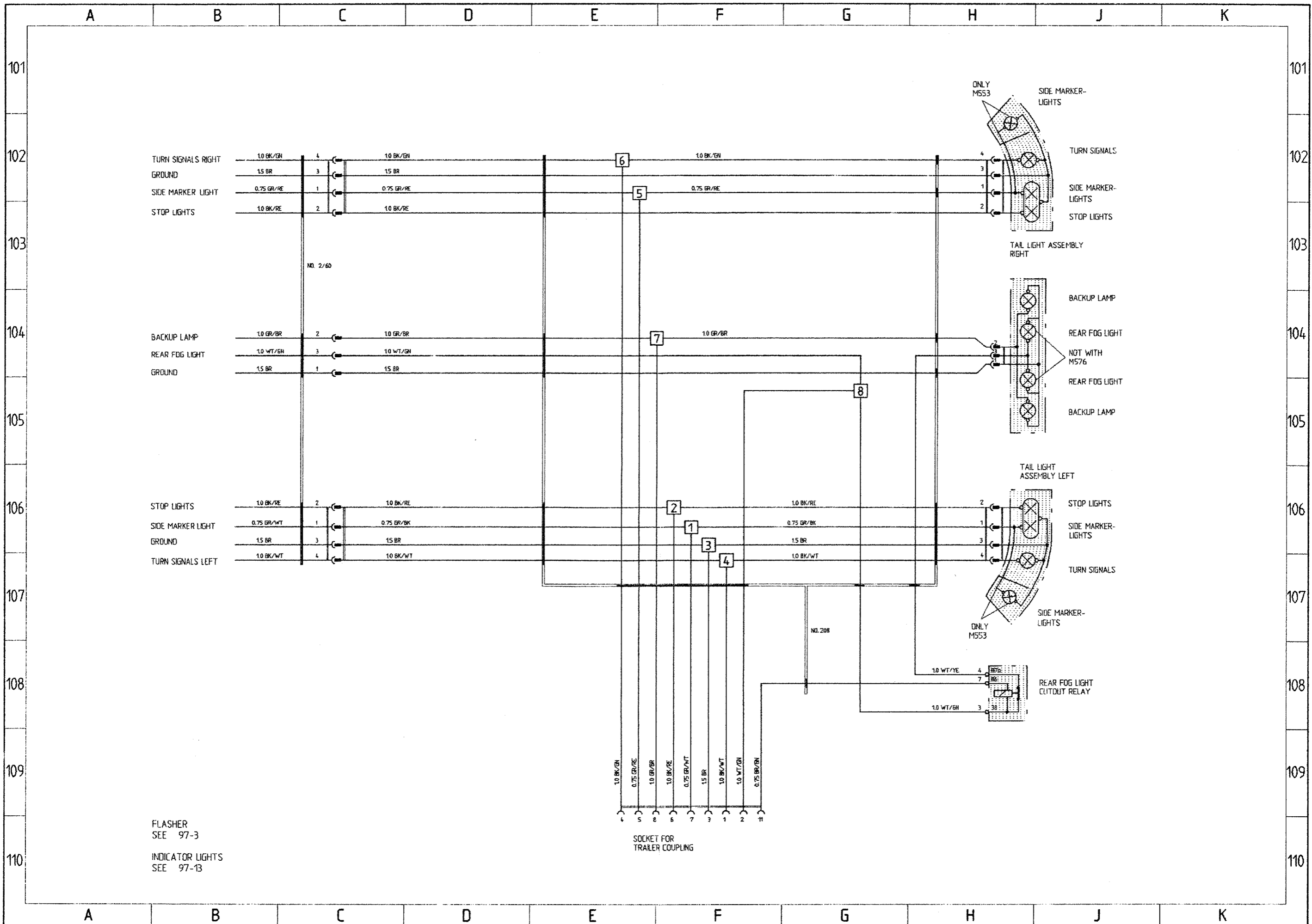

Modifications in wiring diagram 911 Carrera 4 model 89**Sheet 3, K/L 28**

The fuse for the engine compartment heating fan has been changed from 25 A to 30 A.
Please exchange sheet 11.

Please modify the wiring diagram accordingly.

Wiring Diagram

Type 911 Carrera 2 and 4

Model 90

	Coordinates	
Sheet 1	1 - 10	Lights
Sheet 2	11 - 20	Alarm System, Central Locks, Mirror, Power Window Regulator
Sheet 3	21 - 30	Heater, AC, Coolant Fan, Rear Window Defogger
Sheet 4	31 - 40	ABS, Porsche Dynamic AWD Control (Carrera 4)
Sheet 4a	31 - 40	ABS (Carrera 2)
Sheet 5	41 - 50	Motor, Ignition, Cruise Control
Sheet 6	51 - 60	Instruments, Sender, Central Informer
Sheet 7	61 - 70	Seats
Sheet 8	71 - 80	Rear Spoiler, Two-Tone Horns, Wipe- and Wash Cleaners, Sun Roof, Convertible Top
Sheet 9	81 - 90	Radio
Sheet 10	91 - 100	Fog Light, Rear Fog Light
Sheet 11		Central Electric
Sheet 12		Construction Components
Sheet 13		Plug Connections, Ground Points, M-Numbers
Sheet 14	101 - 110	Trailer Coupling
Sheet 15	111 - 120	Rev-meter, On-board computer, Airbag
Sheet 16	121 - 130	Tiptronic (Carrera 2)

Wiring Diagram

Type 911 Carrera 2 and 4

Model 90

The wiring diagram consists of *15 individual wiring diagrams*, 1 sheet *construction components* and 1 sheet *plug connections and ground points*. These are divided into coordinate fields.

Each individual wiring diagram contains a part of the central-electrics box in a dashdotted frame.

This part of the central-electrics box shows all the lines and relays necessary for the individual wiring diagram.

The earth/ground points are identified by "MP" and their location is shown in a vehicle diagram.

The 10-pin connectors on the central-electrics box are clipped together out of 3 parts, the 20-pin connectors are clipped together out of 5 parts.

Part 1, with the moduled-on fastening lug, is the "starting element".

Parts 2,3 and 4 are "module elements".

The 10-pin connectors only contents one "module element".

Start- and module elements are identified by the numbers 1.....5.

Part 5 ist a "coding element".

The designations of the plug connections in the wiring diagram refer to the "starting element" from, for example, B 11.....15, and to the first module element from B 21.....25.

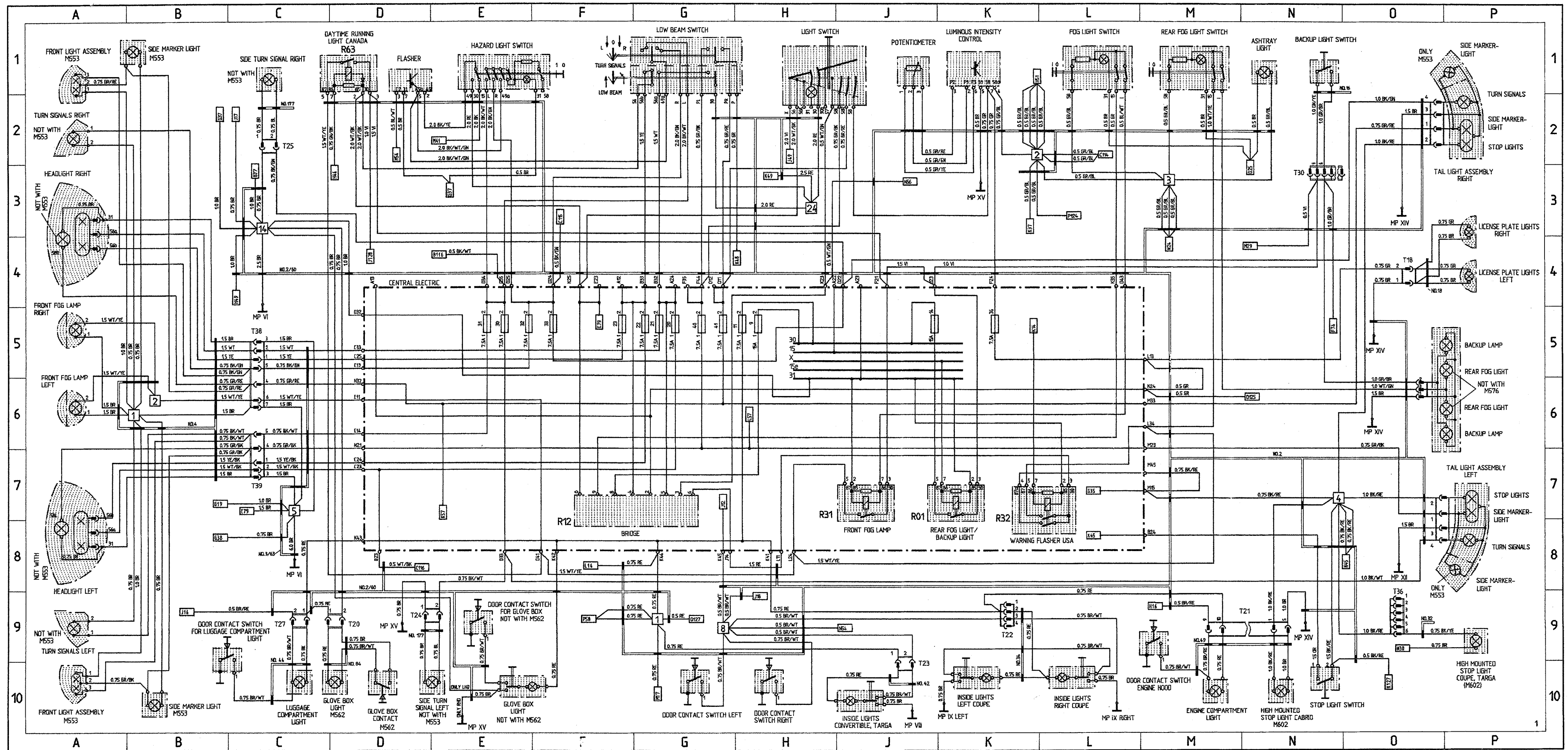

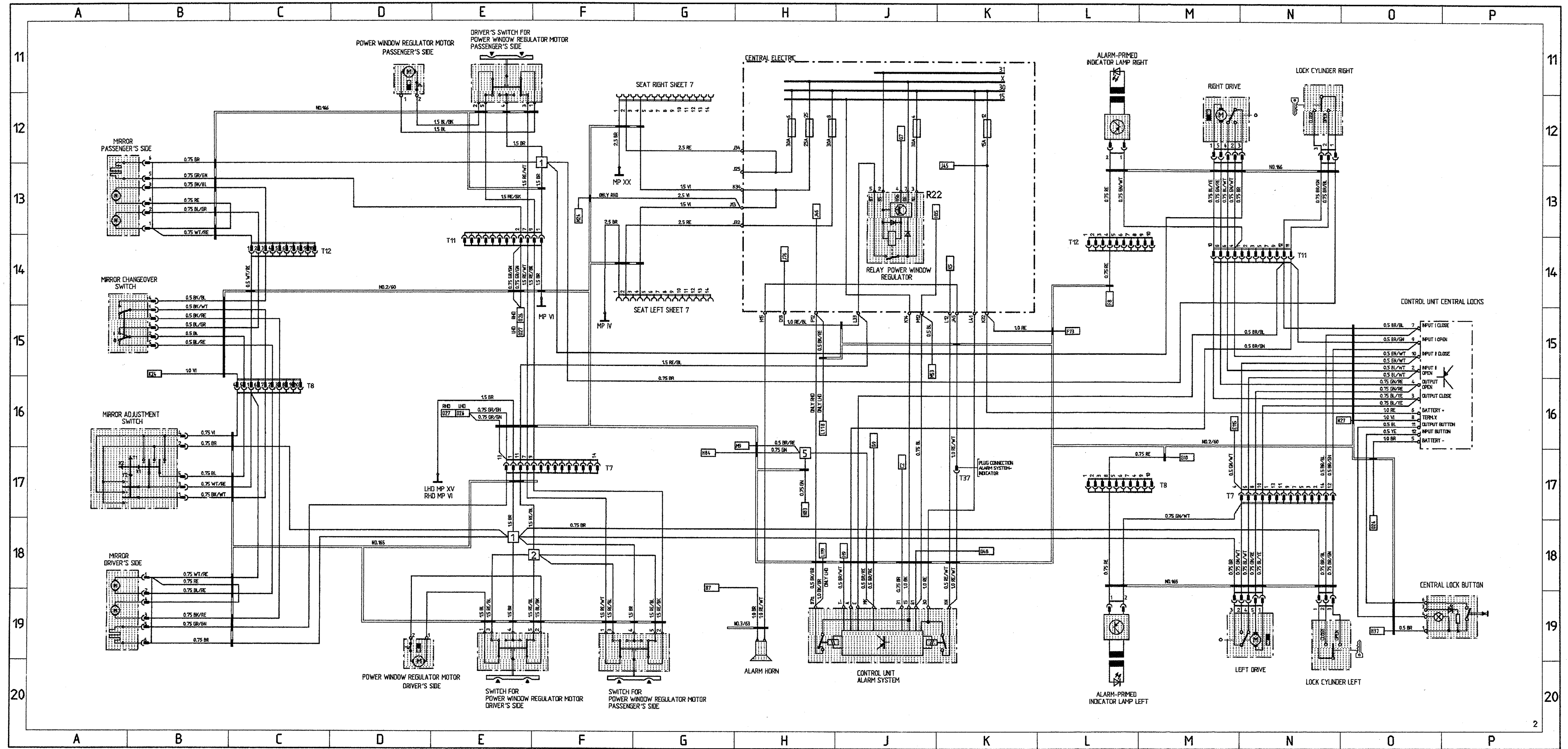

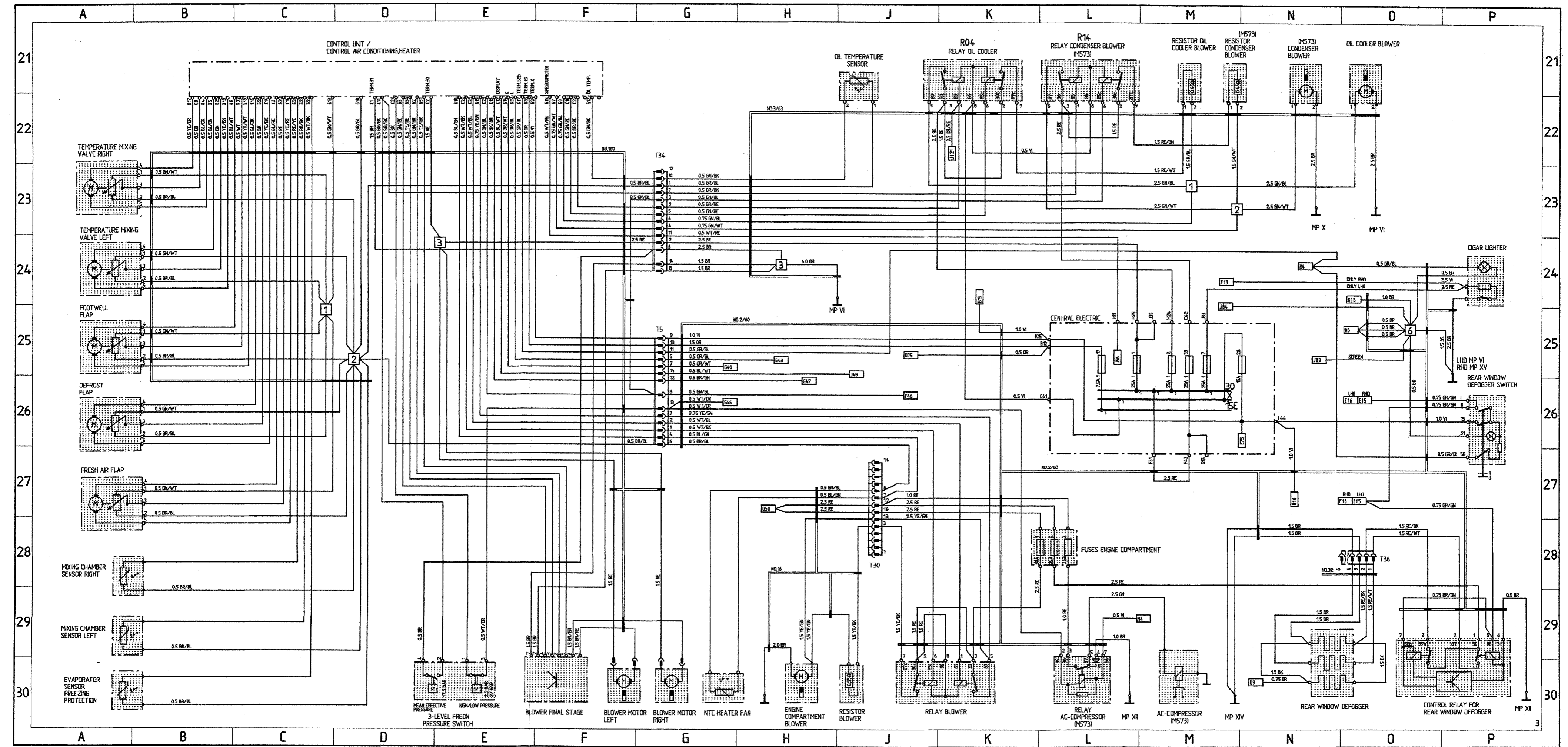

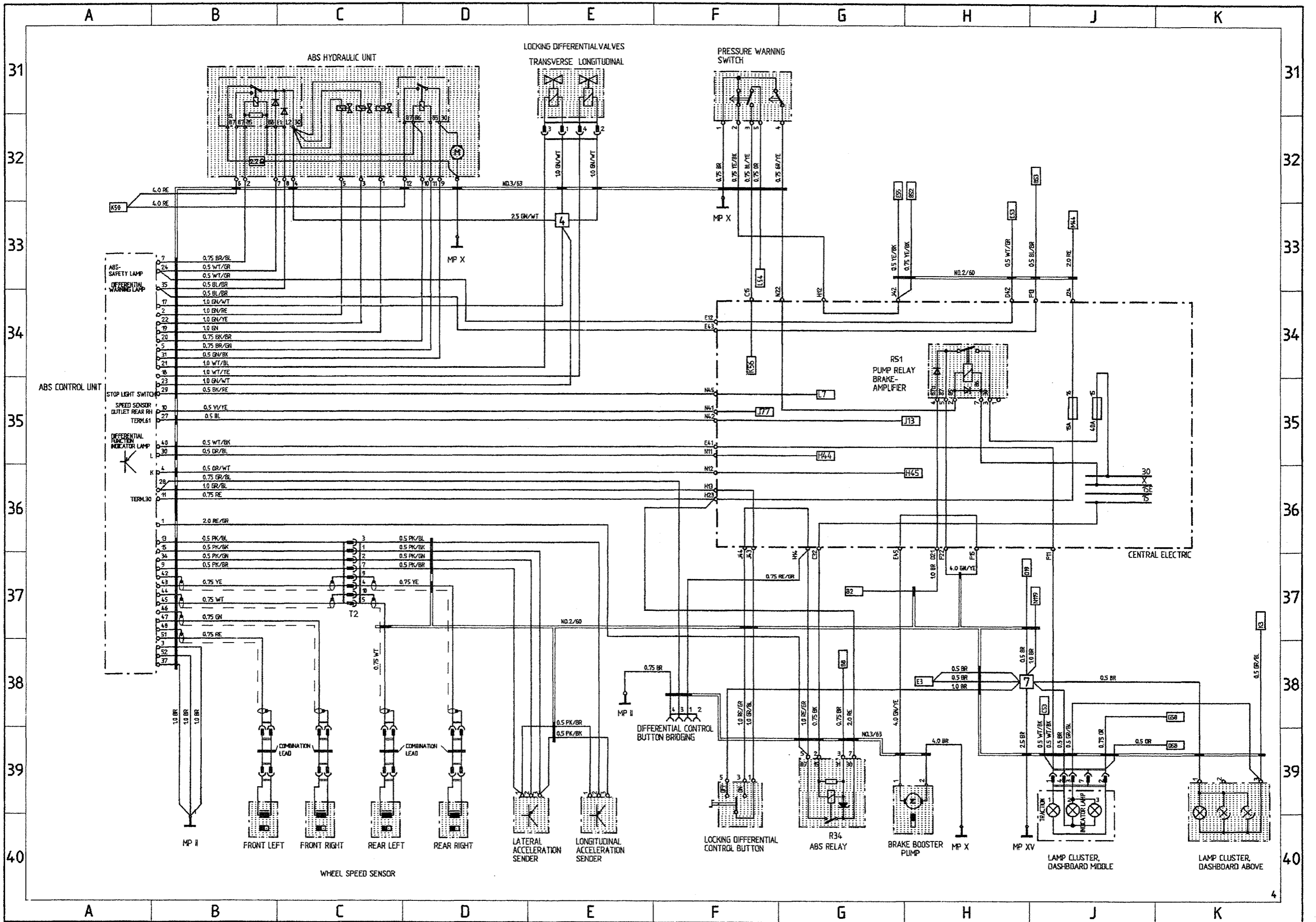

ABS

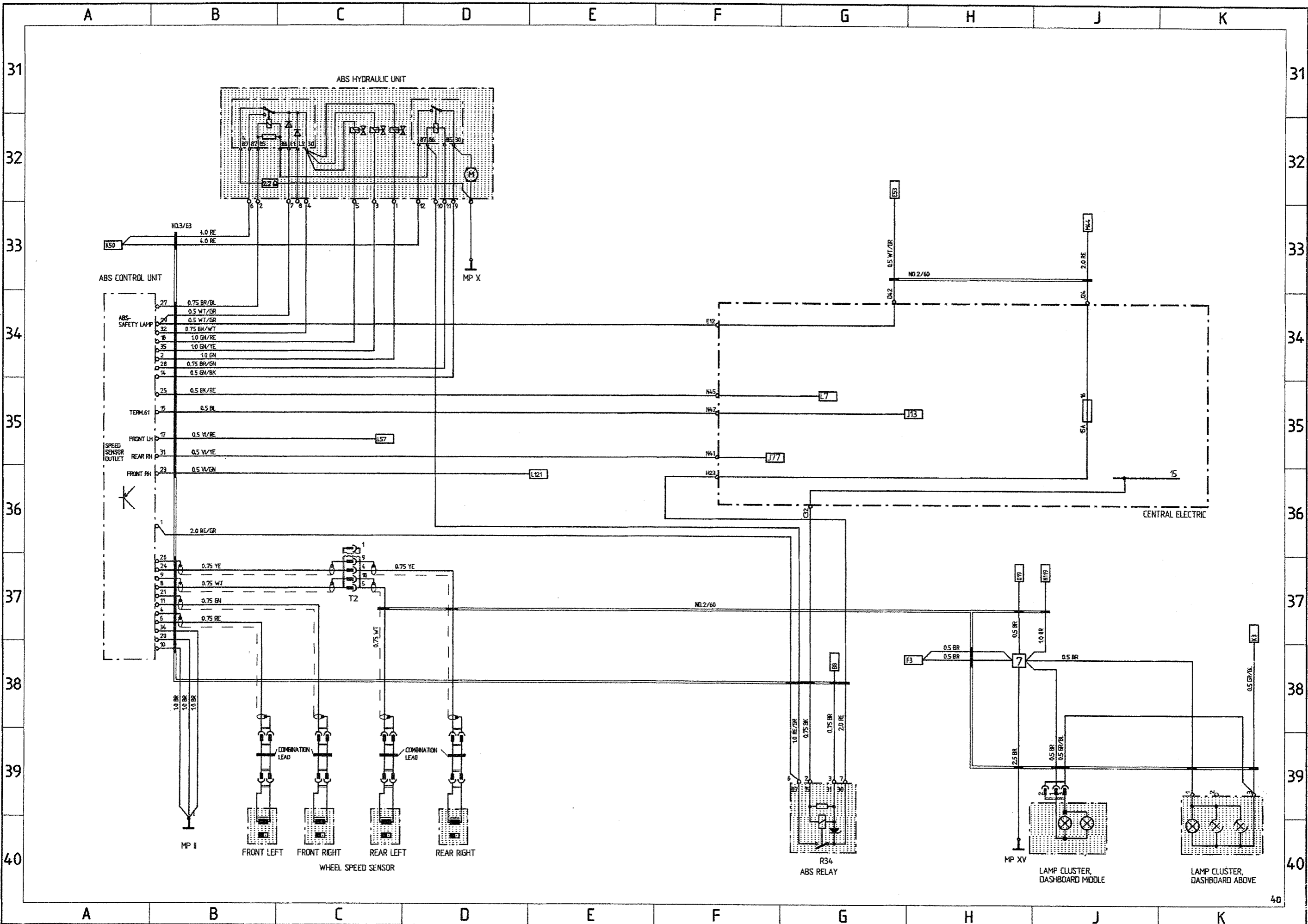

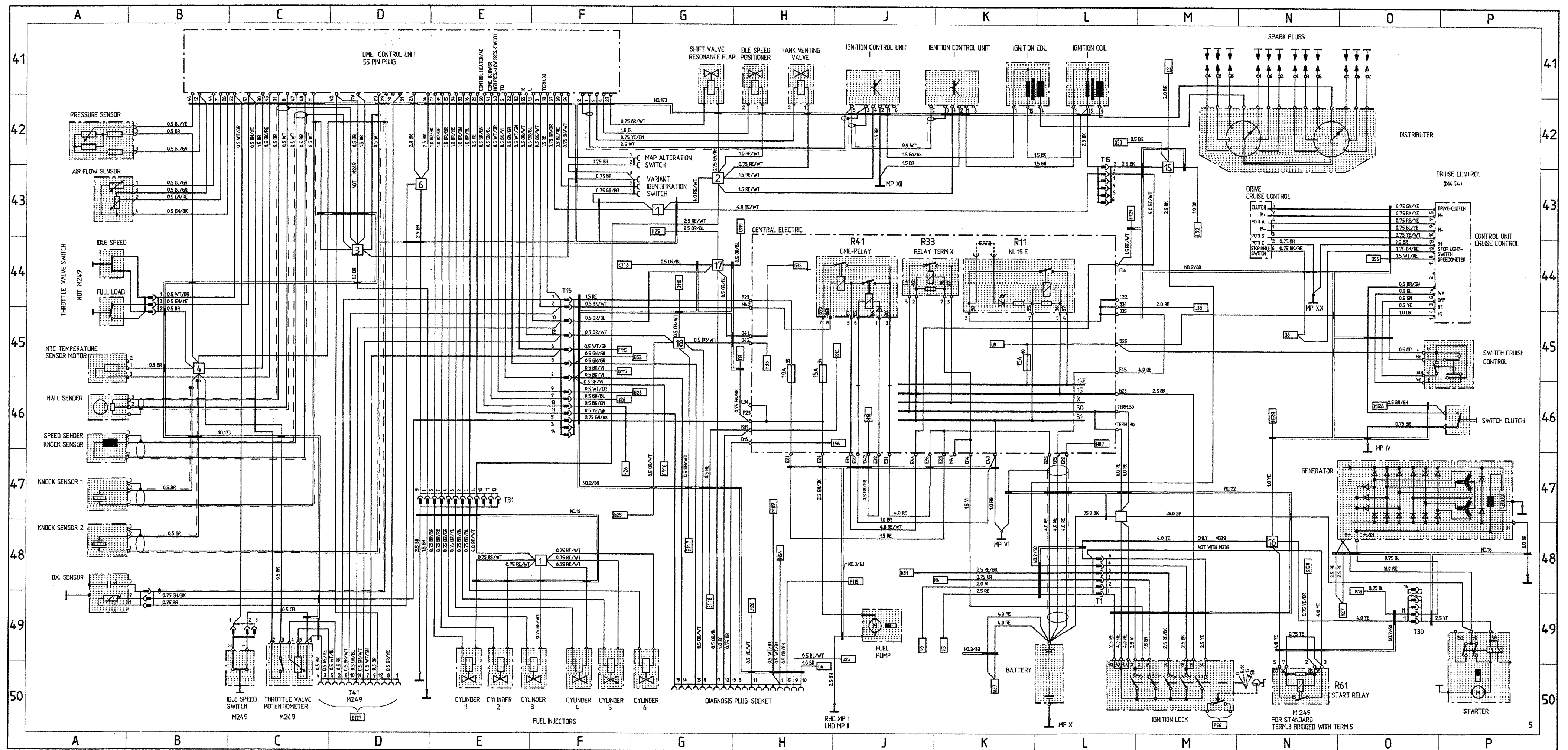

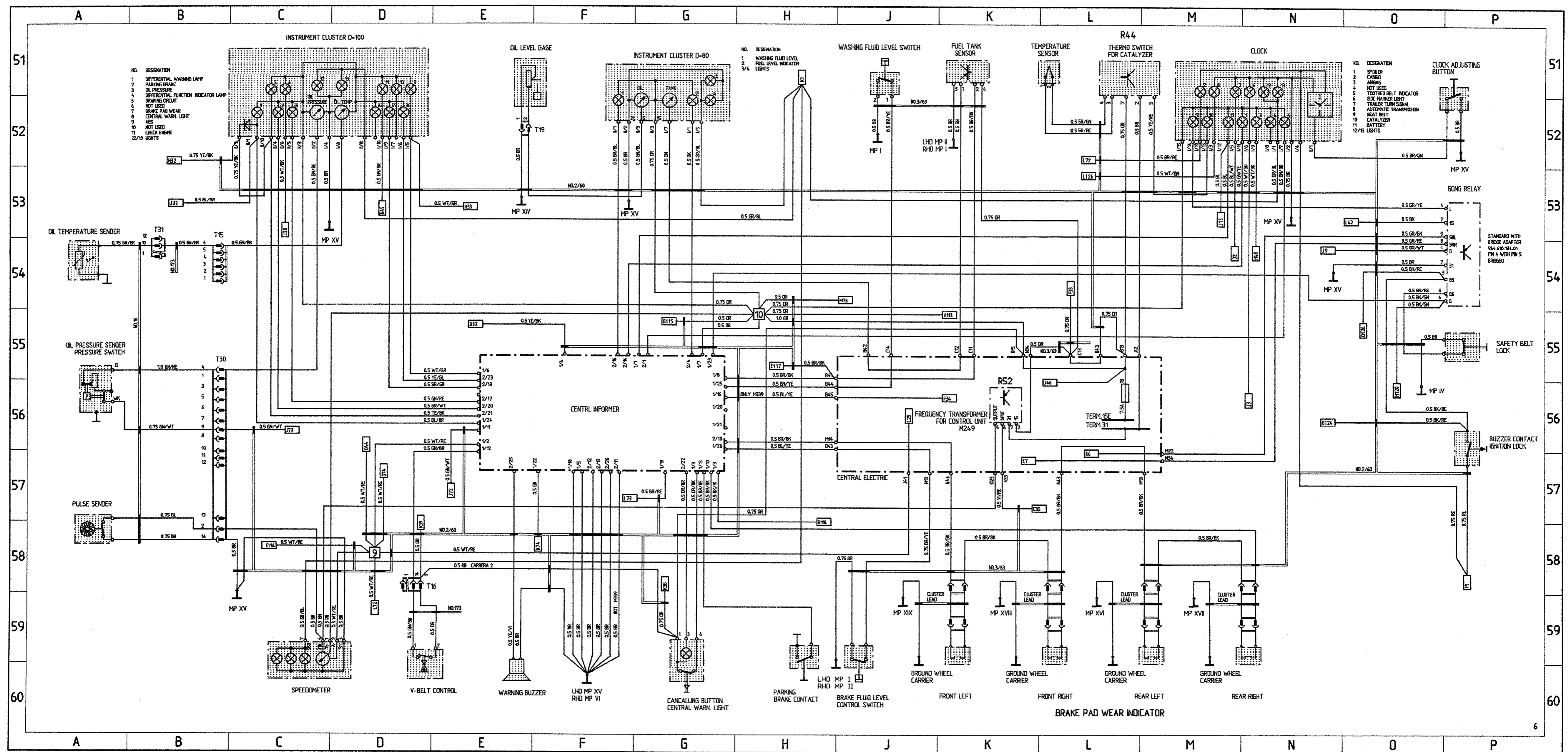

SEATS

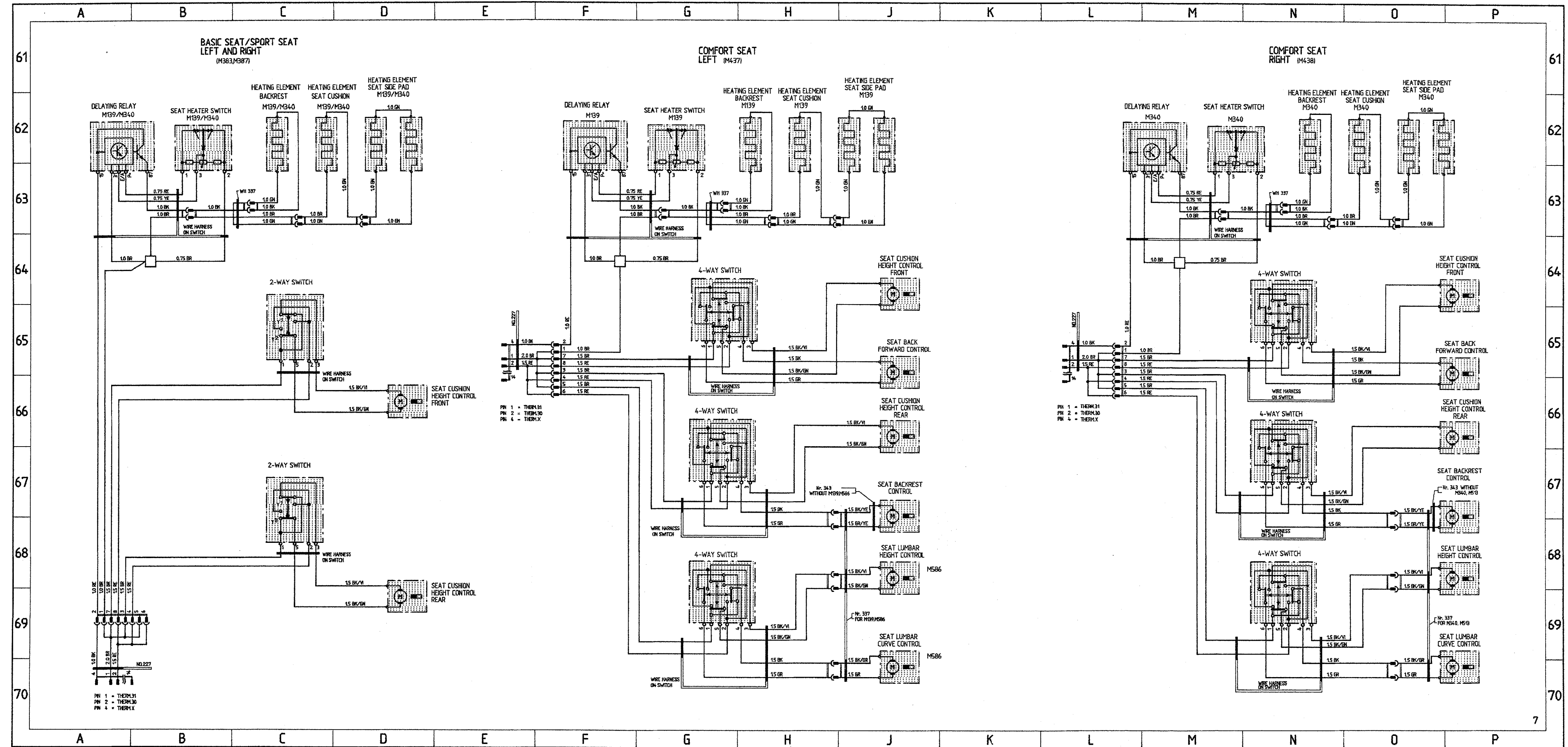

PN 1 = THERM.31
 PN 2 = THERM.30
 PN 4 = THERM.X

PN 1 = THERM.31
 PN 2 = THERM.30
 PN 4 = THERM.X

PN 1 = THERM.31
 PN 2 = THERM.30
 PN 4 = THERM.X

Nr. 337 FOR M59/M58

Nr. 343 WITHOUT M59/M58

REAR SPOILER, TWO-TONE HORNS, WIPE- AND WASH CLEANERS, SUN ROOF, CONVERTIBLE TOP

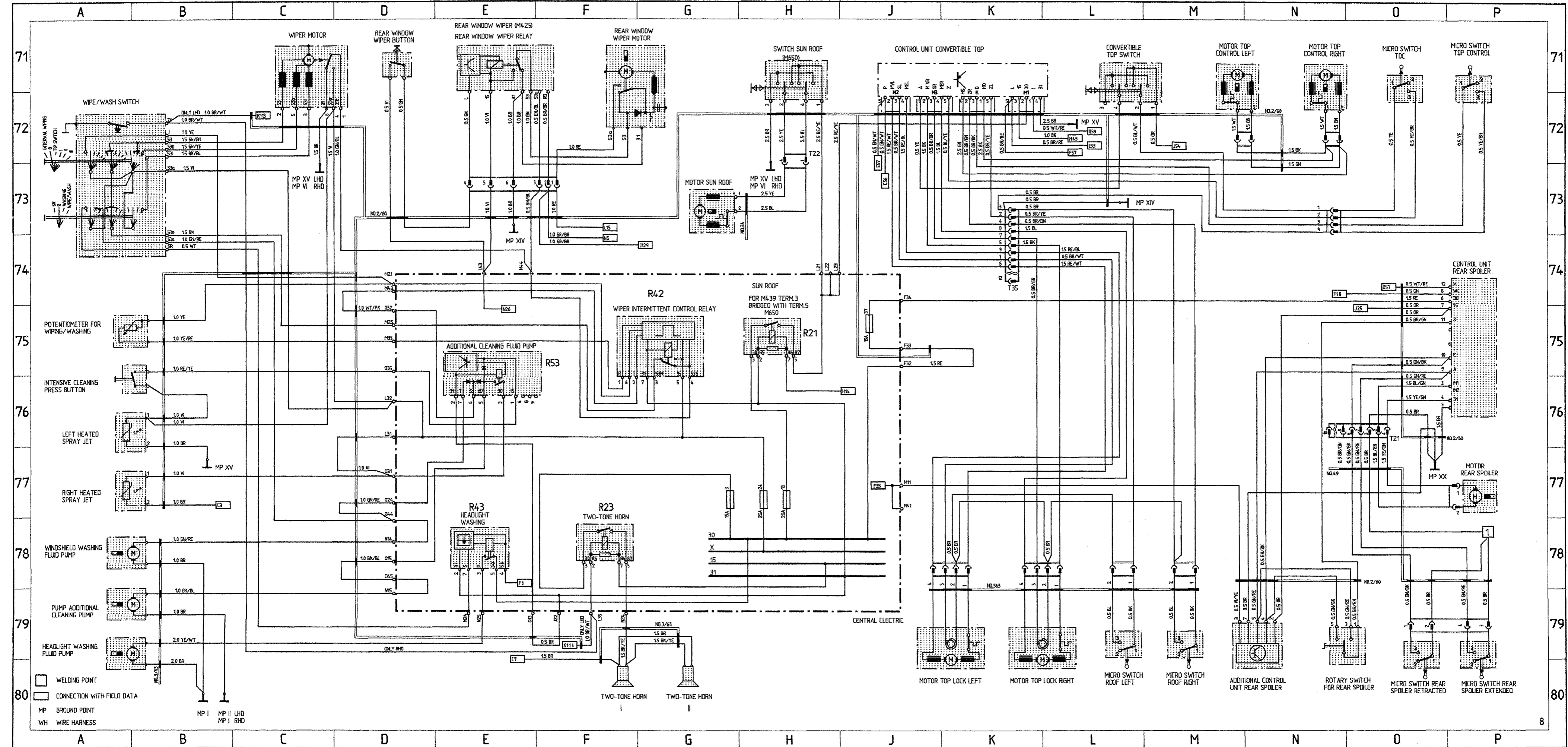

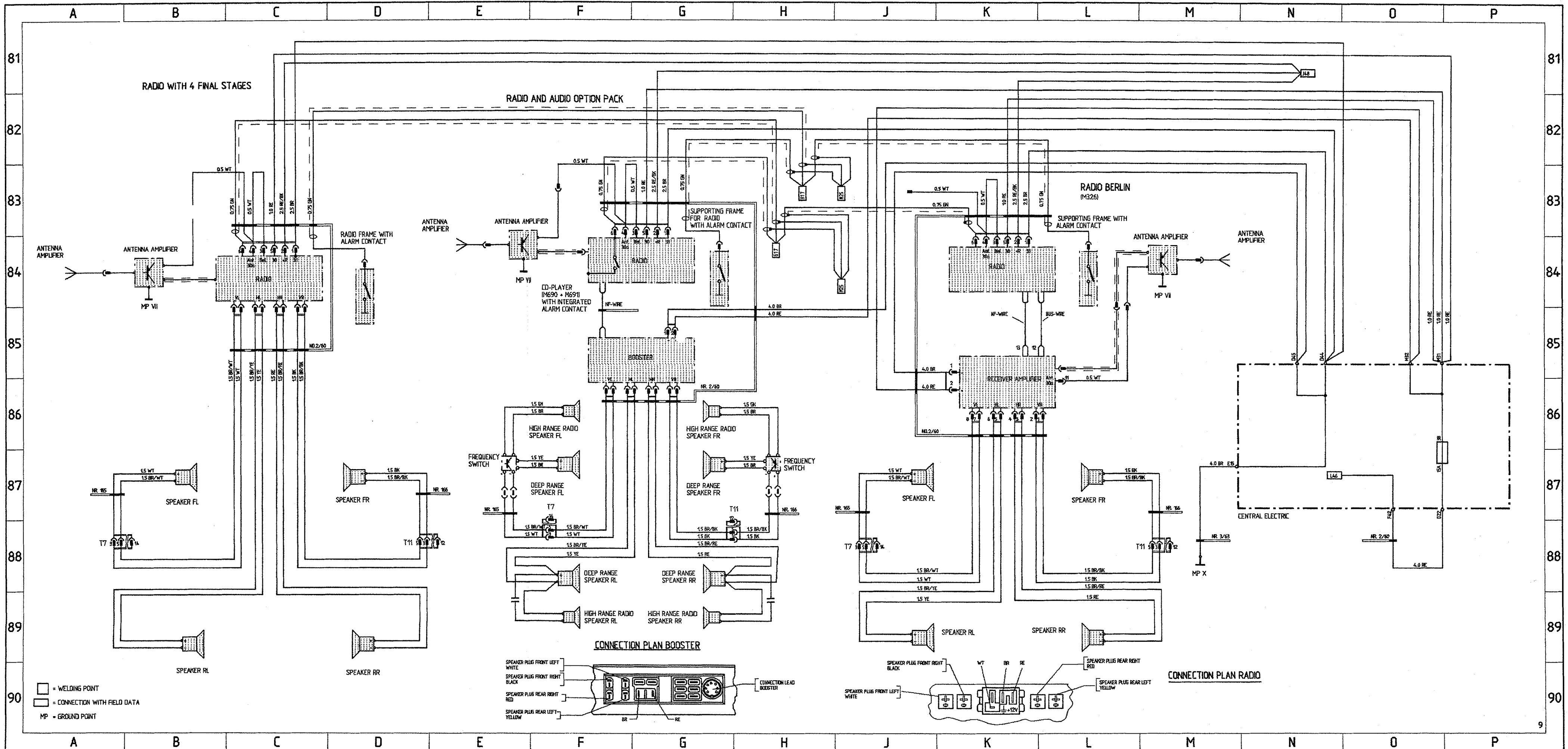

FOG LIGHT- AND REAR FOG LIGHT - WIRINGS

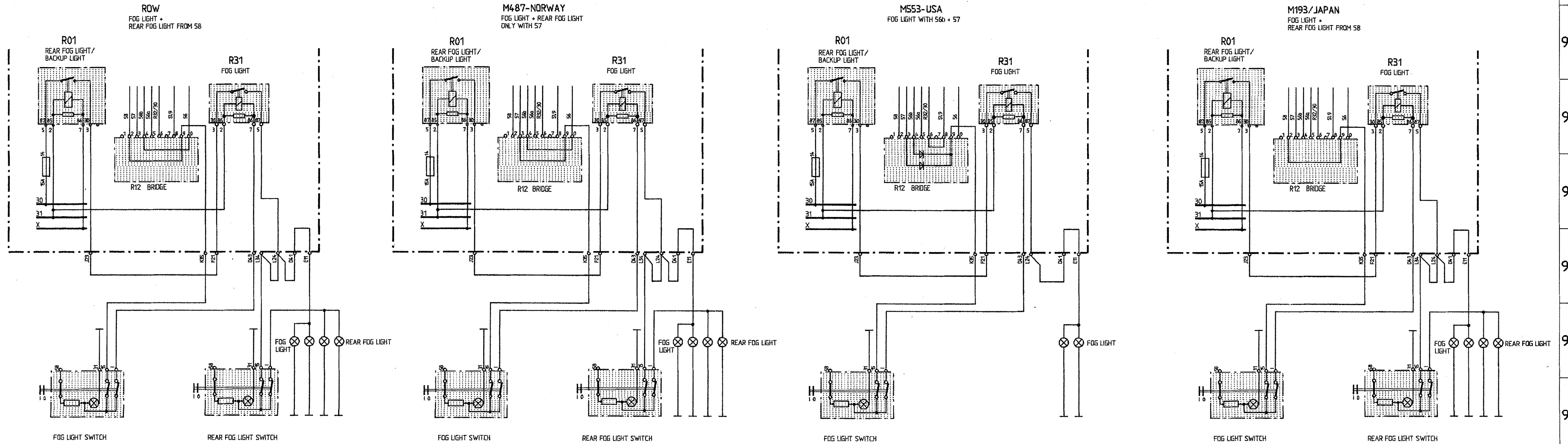

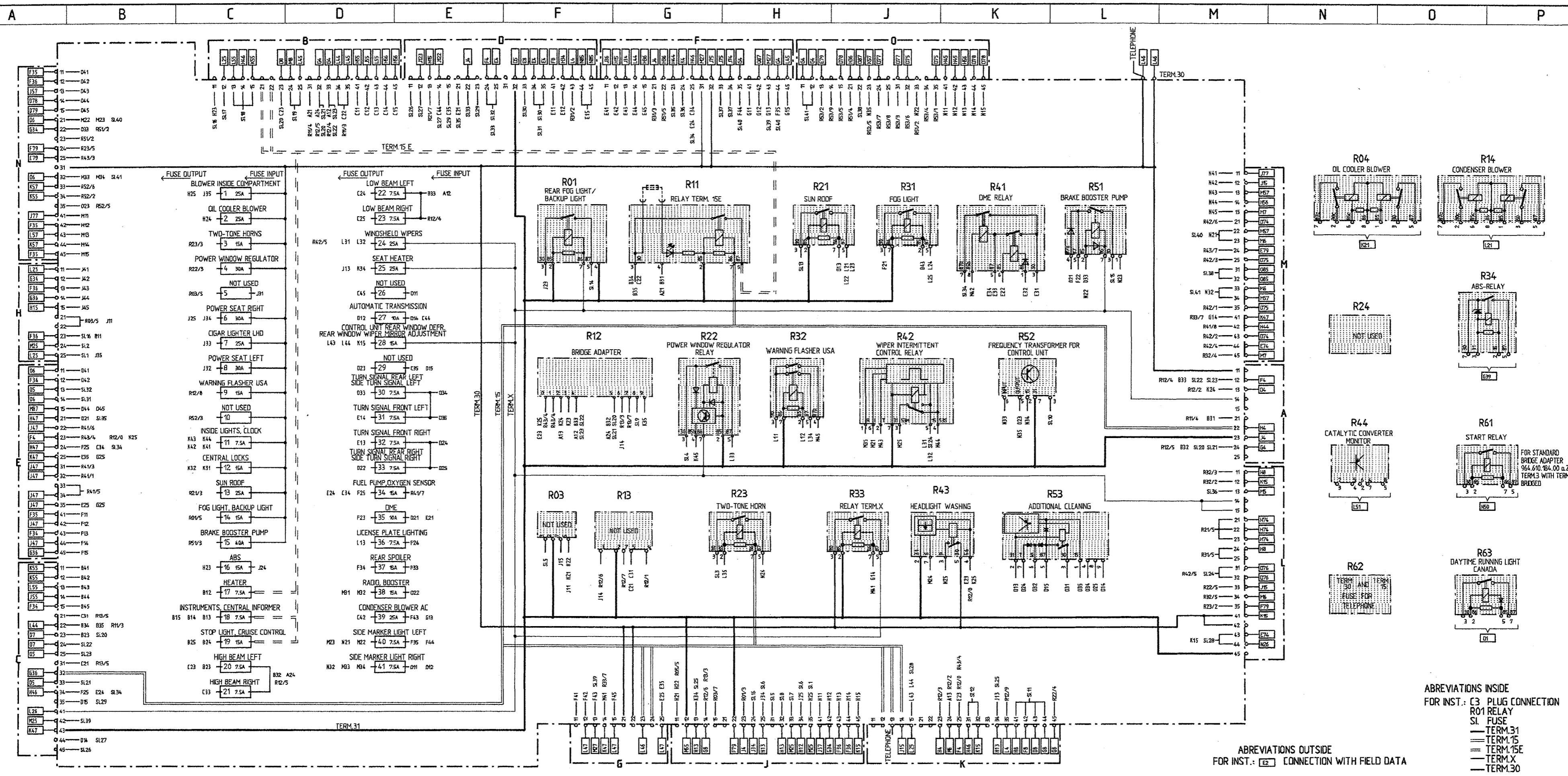

ABBREVIATIONS INSIDE
FOR INST.: C3 PLUG CONNECTION
R01 RELAY
SL FUSE
TERM.31
TERM.15
TERM.15E
TERM.X
TERM.30

ABBREVIATIONS OUTSIDE
FOR INST.: E2 CONNECTION WITH FIELD DATA

CONSTRUCTION COMPONENTS

DESIGNATION, FUNCTION	POSITION IN VEHICLE LHD	RHD	NOTE	FIELD IN WIRING DIAGRAM
ABS RELAY	6cM	6cM	CENTRAL ELECTRIC	G39/40
ALARM HORN	3cL	3cL	IN WHEEL HOUSING FRONT RIGHT	H19
ANTENNA AMPLIFIER	7bL	7bQ	IN LUGGAGE COMPARTMENT	B84,E84,M84
EXTERIOR TEMPERATURE TRANSMITTER	8bR	8bK	IN OUTSIDE MIRROR	D118
FLASHER	7dN	7dN	IN CENTRE CONSOLE	D1
BOOSTER	9eM	9eM	UNDER THE SEAT RIGHT	F/G85
STOP LIGHT SWITCH	6dP	6dM	AT THE BRAKE PEDAL BELOW THE FLOOR PANEL	H10
DIAGNOSIS CONNECTION	7cL	7cQ	IN PASSENGER'S FOOTWELL	G/H50
DME RELAY	6cM	6cM	CENTRAL ELECTRIC	J44
DME CONTROL UNIT	9eP	9eP	UNDER THE SEAT LEFT	B-F41
SPEED SENDER	15cP	15cP	ON ENGINE LEFT	A47
THROTTLE VALVE POTENTIOMETER AUTOMATIC TRANSMISSION	15bN	15bN	ON THROTTLE VALVE ASSEMBLY	C50
THROTTLE VALVE SWITCH, TRANSMISSION	15bN	15bN	ON THROTTLE VALVE ASSEMBLY	A44/45
PRESSURE SENSOR	10eP	10eP	UNDER THE SEAT LEFT	A42
PRESSURE WARNING SWITCH	1dD	1dD	IN LUGGAGE COMPARTMENT	F31
PRESSURE SWITCH AIR CONDITIONING SYSTEM	6bD		IN LUGGAGE COMPARTMENT	E30
RECEIVER FOR RADIO BERLIN	9eM	9eM	UNDER THE SEAT RIGHT	K86
TWO-TONE HORN I	3cL	3cL	IN WHEEL HOUSING FRONT RIGHT	F80
TWO-TONE HORN II	3cL	3cL	IN WHEEL HOUSING FRONT RIGHT	G80
FREQUENCY SWITCH FRONT LEFT	9dQ	9dQ	UNDER THE DOOR TRIM PANEL	E87
FREQUENCY SWITCH FRONT RIGHT	9dL	9dL	UNDER THE DOOR TRIM PANEL	H87
CRASH SENSOR RIGHT	4cM		IN LUGGAGE COMPARTMENT	N112
CRASH SENSOR LEFT	4cP		IN LUGGAGE COMPARTMENT	K/L112
BLOWER FINAL STAGE	6bN	6bN	IN LUGGAGE COMPARTMENT	F30
BLOWER ENGINE COMPARTM.	16cD	16cD	ON ENGINE	H30
BLOWER MOTOR RIGHT	6cM	6cM	IN LUGGAGE COMPARTMENT	G30
BLOWER MOTOR LEFT	6cP	6cP	IN LUGGAGE COMPARTMENT	F30
GONG RELAY	6cP		ON STEERING COLUMN LEFT	P53/54
HALL SENDER	17cD	17cD	ON DISTRIBUTOR	A46
REAR WINDOW WIPER RELAY	15bD	15bD	ON REAR WINDOW WIPER MOTOR	E71
HYDRAULIC UNIT ABS	3dP	3dP	IN LUGGAGE COMPARTMENT	E32
PULSE SENDER	13dD	13dD	ON GEARBOX	A58
V-BELT CONTROL	17dD	17dD	ON ENGINE	D60
MAP ALTERATION SWITCH	9eP	9eP	UNDER THE SEAT LEFT	B42
KICK-DOWN SWITCH	6dD	6dM	ON ACCELERATOR PEDAL BELOW THE FLOOR PANEL	M122
KNOCK SENSOR 1	15cP	15cP	ON ENGINE LEFT	A47
KNOCK SENSOR 2	16cN	16cN	ON ENGINE ABOVE	A48
CONDENSER BLOWER	2dQ	2dQ	IN WHEEL HOUSING FRONT LEFT	N21
FUEL PUMP	6eM	6eP	BEHIND THE BASE	J49
CLUTCH SWITCH CRUISE CONTROL	6dP	6dN	ON CLUTCH PEDAL BELOW THE FLOOR PANEL	P46
LONGITUDINAL ACCELERATION SENDER	7dN	7dN	IN CENTRE CONSOLE	E40
LOCKING DIFFERENTIAL VALVES, LONGITUDINAL / TRANSVERSE	3dM	3dM	IN LUGGAGE COMPARTMENT	E31
IDLE SPEED SWITCH AUTOMATIC TRANSMISSION	15bN	15bN	ON ENGINE	C50
IDLE SPEED POSITIONER	15bN	15bN	ENGINE COMPARTMENT	H41
AIR FLOW SENSOR	16bD	16bD	ON ENGINE	A43
MICRO SWITCH ROOF RIGHT	9dN	9dN	ON CONVERTIBLE TOP FRAME	M79
MICRO SWITCH ROOF LEFT	9dD	9dD	ON CONVERTIBLE TOP FRAME	L79
MICRO SWITCH REAR SPOILER EXTENDED	16bP	16bP	ON TAILGATE	P79
MICRO SWITCH REAR SPOILER RETRACTED	16bP	16bP	ON TAILGATE	O79
MICRO SWITCH DEAD CENTER	12cL	12cL	SIDE PANEL COVERING RIGHT	O71
MICRO SWITCH FOR CONVERTIBLE CONTROL	12cL	12cL	SIDE PANEL COVERING RIGHT	P71
MOTOR SUN ROOF	12aN	12aN	IN ROOF	G73
MOTOR CONVERTIBLE TOP ACTUATION RIGHT	15cN	15cN	BEHIND REAR SEAT	N71
MOTOR CONVERTIBLE TOP ACTUATION LEFT	15cD	15cD	BEHIND REAR SEAT	M71
MOTOR CONVERTIBLE TOP LOCKING DEVICE RIGHT	9dN	9dN	ON CONVERTIBLE TOP FRAME	K/L79
MOTOR CONVERTIBLE TOP LOCKING DEVICE LEFT	9dD	9dD	ON CONVERTIBLE TOP FRAME	J/K79
REAR FOG LIGHT CUTOUT RELAY	17dN	17dN	BEHIND REAR PANEL	A108
NTC HEATER FAN	16cP	16cP	ENGINE COMPARTMENT	G30
OIL PRESSURE SENDER / SWITCH	14cN	14cN	ON ENGINE	A55/56
OIL COOLER BLOWER	2dL	2dL	IN WHEEL HOUSING FRONT RIGHT	O21
OIL LEVEL GAGE	12cK	12cK	IN WHEEL HOUSING REAR RIGHT	E/F51/52

DESIGNATION, FUNCTION	POSITION IN VEHICLE LHD	RHD	NOTE	FIELD IN WIRING DIAGRAM
OIL TEMPERATURE SENDER FOR INSTRUMENT	14cN	14cN	ON ENGINE	A54
OIL TEMPERATURE SENDER FOR OIL COOLER BLOWER	2dL	2dL	IN WHEEL HOUSING FRONT RIGHT	J21
SWITCH LIFTING	12dD	12dD	ON GEARBOX	B126/127
BRAKE BOOSTER PUMP	1dD	1dD	IN LUGGAGE COMPARTMENT	H39/40
LATERAL ACCELERATION SENDER ABS	7dN	7dN	IN CENTRE CONSOLE	D40
LATERAL ACCELERATION SENDER AUTOMATIC TRANSMISSION	7dN	7dN	IN CENTRE CONSOLE	K129
CONTROL RELAY REAR WINDOW DEFOGGER	16cP	16cP	CARRIER PLATE IN ENGINE COMPARTMENT	D/P29/30
RELAY CONDENSER BLOWER	6cM	6cM	CENTRAL ELECTRIC	L21
RELAY AC COMPRESSOR	16cP	16cP	CARRIER PLATE IN ENGINE COMPARTMENT	L30
RELAY ALARM SYSTEM USA	6cM	6cM	CENTRAL ELECTRIC	K/L17
RELAY TWO-TONE HORN	6cM	6cM	CENTRAL ELECTRIC	F78
RELAY POWER WINDOW REGULATOR	6cM	6cM	CENTRAL ELECTRIC	J3/14
RELAY FREQUENCY TRANSFORMER	6cM	6cM	CENTRAL ELECTRIC	K56
RELAY BLOWER ENGINE COMPARTM.	16cP	16cP	CARRIER PLATE IN ENGINE COMPARTMENT	J/K30
RELAY STARTER AUTOMATIC TRANSMISSION	6cM	6cM	CENTRAL ELECTRIC	N50
RELAY ADDITIONAL CLEANING FLUID PUMP	6cM	6cM	CENTRAL ELECTRIC	E75/76
RELAY TEMP. SWITCH CATALYZER	6cM	6cM	CENTRAL ELECTRIC	L/M51
RELAY TERM.X	6cM	6cM	CENTRAL ELECTRIC	K44
RELAY TERM.15 E	6cM	6cM	CENTRAL ELECTRIC	K/L44
RELAY REAR FOG LIGHT - BACKUP LIGHT	6cM	6cM	CENTRAL ELECTRIC	J/K7
RELAY FRONT FOG LAMP	6cM	6cM	CENTRAL ELECTRIC	J7
RELAY OIL COOLER BLOWER	6cM	6cM	CENTRAL ELECTRIC	K21
RELAY BRAKE BOOSTER PUMP	6cM	6cM	CENTRAL ELECTRIC	H34/35
RELAY SUN ROOF	6cM	6cM	CENTRAL ELECTRIC	H75
RELAY DAYTIME RUNNING LIGHT CANADA	6cM	6cM	CENTRAL ELECTRIC	D1
BACKUP LIGHT SWITCH	14dN	14dN	ON GEARBOX RIGHT	N1
SHIFT VALVE RESONANCE FLAP	15bN	15bN	ON ENGINE	G41
WINDSHIELD WASHING FLUID PUMP	3cQ	3cQ	ON WINDSHIELD WASHER TANK IN WHEEL HOUSING FRONT LEFT	A78
FUSES ENGINE COMPARTMENT	16cP	16cP	CARRIER PLATE IN ENGINE COMPARTMENT	L28
HEADLIGHT CLEANER PUMP	3cQ	3cQ	ON WINDSHIELD WASHER TANK IN WHEEL HOUSING FRONT LEFT	A79/80
HEADLIGHT CLEANER RELAY	6cM	6cM	CENTRAL ELECTRIC	E78
STARTER	14dN	14dN	ON CLUTCH BELL HOUSING RIGHT	P49/50
DRIVE CRUISE CONTROL	15cD	15cD	ON ENGINE	N43/44
CONTROL UNIT ABS	2dM	2dM	IN LUGGAGE COMPARTMENT	A33-38
CONTROL UNIT AIRBAG	6cD		ON INSTRUMENT PANEL	P114/115
CONTROL UNIT ALARM SYSTEM	7dL	7cQ	IN LUGGAGE COMPARTMENT	J19
CONTROL UNIT AUTOMATIC TRANSMISSION	10dP	10dP	UNDER THE SEAT RIGHT	C-G122
CONTROL UNIT CONVERTIBLE TOP	6cP	6cM	ON INSTRUMENT PANEL	J/K71
CONTROL UNIT INSTRUMENT LIGHTS	7bD	7bD	IN LUGGAGE COMPARTMENT LEFT	K1
CONTROL UNIT REAR SPOILER	9eN	9eN	UNDER THE SEAT RIGHT	P74-76
CONTROL UNIT HEATER, AIR CONDITIONER	7cD	7cN	ON INSTRUMENT PANEL	B-F21
CONTROL UNIT CRUISE CONTROL	9eN	9eN	UNDER THE SEAT RIGHT	P43/44
CONTROL UNIT CENTRAL LOCKS	6cN	6cN	UNDER THE INSTRUMENT PANEL	P15/16
BUZZER CONTACT	7cP	7cM	ON IGNITION LOCK	P56
FUEL LEVEL SENDER	5cM	5cP	IN FUEL TANK	K51
TANK VENTING VALVE	15cN	15cN	ON ENGINE ABOVE	H41
TEMPERATURE MOTOR	15cP	15cP	ON ENGINE LEFT	A45
VARIANT IDENTIFICATION SWITCH	9eP	9eP	UNDER THE SEAT LEFT	G43
RESISTOR BLOWER	16dP	16dP	ENGINE COMPARTMENT	J30
RESISTOR CONDENSER BLOWER	2dQ	2dQ	IN WHEEL HOUSING FRONT LEFT	M21
RESISTOR OIL COOLER BLOWER	2dL	2dL	IN WHEEL HOUSING FRONT RIGHT	M21
WARNING BUZZER	7cP	7cP	ON INSTRUMENT PANEL	E60
WIPER INTERMITTENT CONTROL RELAY	6cM	6cM	CENTRAL ELECTRIC	F/G75
CENTRAL ELECTRIC	6cM	6cM	IN LUGGAGE COMPARTMENT	
CENTRAL INFORMER	6cP	6cP	ON STEERING COLUMN	F56
IGNITION CONTROL UNIT I	15cP	15cP	ENGINE COMPARTMENT LEFT	K41
IGNITION CONTROL UNIT II	15cP	15cP	ENGINE COMPARTMENT LEFT	J41
IGNITION COIL I	15cQ	15cQ	ENGINE COMPARTMENT LEFT	L41
IGNITION COIL II	15cQ	15cQ	ENGINE COMPARTMENT LEFT	K41
ADDITIONAL CLEANING FLUID PUMP	4cM	4cQ	IN LUGGAGE COMPARTMENT	A79
ADDITIONAL CONTROL UNIT REAR SPOILER	9eM	9eM	UNDER THE SEAT RIGHT	N79

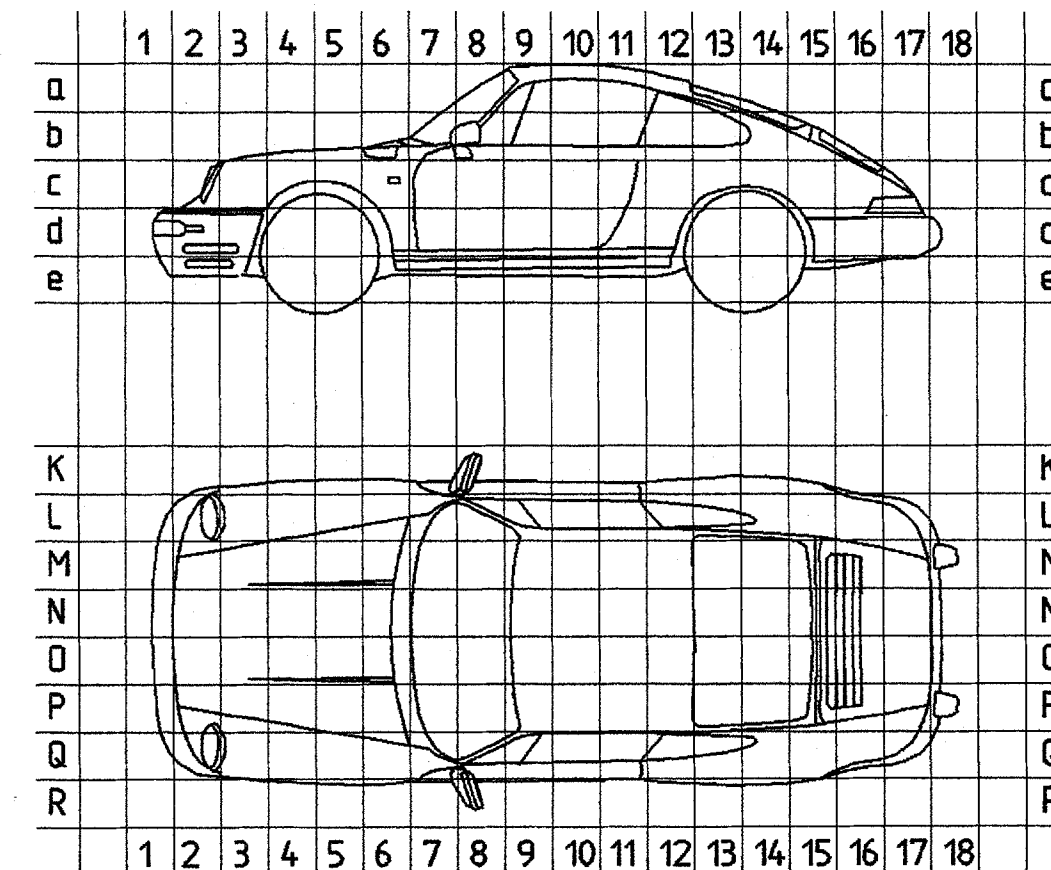

PLUG CONNECTIONS AND GROUND POINTS

A B C D E F G H J K L M N O P

PLUG CONNECTIONS

CODE	NUMBER OF PINS	DESIGNATION, FUNCTION	POSITION IN VEHICLE LHD	NOTE	FIELD
T1	6	IGNITION LOCK	6cP	6cM	ON STEERING COLUMN LEFT L48
T2	10	ABS	6cL	6cL	IN LUGGAGE COMPARTMENT RIGHT C36/37, K122
T5	14	HEATER, AIR CONDITIONER	6cM	6cM	UNDER THE INSTRUMENT PANEL RIGHT G25/26
T6	6	AIRBAG	7dN	7dN	IN CENTRE CONSOLE M117
T7	14	DOOR DRIVER'S SIDE	6cQ	6cL	UNDER THE INSTRUMENT PANEL LEFT A88F88, J88E/F17, N17
T8	10	DOOR DRIVER'S SIDE	6cQ	6cL	UNDER THE INSTRUMENT PANEL LEFT C16, E117, L17
T9	2	AIRBAG	7dN	7dN	IN CENTRE CONSOLE N117
T11	12	DOOR PASSENGER'S SIDE	6cL	6cQ	UNDER THE INSTRUMENT PANEL RIGHT E14, M/N14, D88, J88, M88
T12	10	DOOR PASSENGER'S SIDE	6cL	6cQ	UNDER THE INSTRUMENT PANEL RIGHT C14, L/M14
T15	6	DME	9eP	9eP	UNDER THE SEAT LEFT L43/B54
T16	14	DME	9eP	9eP	UNDER THE SEAT LEFT F45/46, D58
T18	2	LICENSE PLATE LIGHTS	17dL	17dL	TAIL LIGHTS RIGHT D4
T19	2	OIL LEVEL GAGE	15cM	15cM	ENGINE COMPARTMENT RIGHT ES2
T20	2	GLOVE BOX LAMP, AIRBAG	6cL	—	UNDER THE INSTRUMENT PANEL RIGHT C/D9
T21	10	TAILGATE	15cL	15cL	ENGINE COMPARTMENT RIGHT M/N9, N76
T22	4	INSIDE LIGHTS, SUN ROOF	15dM	15dM	BELOW THE PARCEL TRAY K9, H73
T23	2	INSIDE LIGHTS CONVERTIBLE, TARGA	6cQ	6cQ	UNDER THE INSTRUMENT PANEL LEFT J10
T24	2	SIDE TURN SIGNAL LEFT	7bQ	7bQ	IN LUGGAGE AT THE LONGITUDINAL SUPPORT LEFT D/E9
T25	2	SIDE TURN SIGNAL RIGHT	7bL	7bL	IN LUGGAGE AT THE LONGITUDINAL SUPPORT RIGHT C2
T27	2	LUGGAGE COMPARTMENT LIGHT	7bL	7bL	IN LUGGAGE AT THE LONGITUDINAL SUPPORT RIGHT C9
T30	14	NO. 16 MOTOR	16cP	16cP	CARRIER PLATE IN ENGINE COMPARTMENT N/03, J27/28, 048/49, B55-58
T31	12	MOTOR, DME	16cP	16cP	CARRIER PLATE IN ENGINE COMPARTMENT D/E47, B54
T34	14	HEATER, AIR CONDITIONER	6cM	6cM	IN LUGGAGE COMPARTMENT RIGHT G23/24
T35	12	CONVERTIBLE TOP	12cL	12cL	SIDE PANEL COVERING RIGHT K73/74
T36	6	REAR WINDOW	15dM	15dM	BELOW THE PARCEL TRAY D9, D28
T37	1	ALARM SYSTEM INDICATOR	7bL	7bQ	IN LUGGAGE COMPARTMENT K17
T38	7	NO. 4, FRONT LIGHTS	3cL	3cL	IN WHEEL HOUSING FRONT RIGHT C5/6
T39	5	NO. 4, FRONT LIGHTS	3cL	3cL	IN WHEEL HOUSING FRONT RIGHT C6/7
T40	30	AUTOMATIC TRANSMISSION	9eP	9eP	UNDER THE SEAT LEFT H124/125
T41	12	AUTOMATIC TRANSMISSION	9eP	9eP	UNDER THE SEAT LEFT C/D50, E127

M - NUMBERS

M 139	ADJUSTABLE SEAT HEATING SEAT LEFT
M 193	JAPAN VERSION
M 249	AUTOMATIC TRANSMISSION
M 326	RADIO BERLIN
M 340	ADJUSTABLE SEAT HEATING SEAT RIGHT
M 383	SPORT SEAT LEFT HEIGHT ELECTR. ADJUSTABLE
M 387	SPORT SEAT RIGHT HEIGHT ELECTR. ADJUSTABLE
M 425	REAR WINDOW WIPER
M 437	COMFORT SEAT LEFT
M 438	COMFORT SEAT RIGHT
M 439	ELECTRIC CONVERTIBLE TOP
M 454	CRUISE CONTROL
M 513	LUMBAR SUPPORT SEAT RIGHT
M 553	USA - CANADA VERSION
M 562	AIRBAG
M 573	RELAY CONDENSER BLOWER
M 576	WITHOUT REAR FOG LIGHT
M 586	LUMBAR SUPPORT SEAT LEFT
M 602	HIGH MOUNTED STOP LIGHT
M 650	SUN ROOF
M 659	ON-BOARD COMPUTER

GROUND POINTS

CODE	NOTE	POSITION IN VEHICLE LHD
MP I	LUGGAGE COMPARTMENT, WHEEL HOUSING LEFT	2cP
MP II	LUGGAGE COMPARTMENT, WHEEL HOUSING RIGHT	2cM
MP III	ON FIREWALL	—
MP IV	GROUND OF POWER CONSUMERS, UNDER THE SEAT LEFT	11eP
MP V	ELEKTRONIC, UNDER THE SEAT LEFT	10eP
MP VI	CENTRAL ELECTRIC, ON LONGITUDINAL SUPPORT RIGHT	6dL
MP VII	ANTENNA AMPLIFIER, ON LONGITUDINAL SUPPORT RIGHT	7bL
MP VIII	INSIDE LIGHTS CONVERTIBLE, ROOF, CENTER, FRONT	9aM
MP IX	INSIDE LIGHTS, ROOF RIGHT	11aL
MP IX	INSIDE LIGHTS, ROOF LEFT	11aP
MP X	BATTERY, LUGGAGE COMPARTMENT LEFT	3eP
MP XI	GROUND STRAP (STARTER, TRANSMISSION, MOTOR, BODY)	14cM
MP XII	ENGINE COMPARTMENT REAR LEFT	15cQ
MP XIII	MOTOR LEFT	15cQ
MP XIV	ENGINE COMPARTM. REAR RIGHT	15cL
MP XV	INSTRUMENTS, LONGITUDINAL SUPPORT LEFT	7bQ
MP XVI	COMBINATION LEAD REAR LEFT	13dP
MP XVII	COMBINATION LEAD REAR RIGHT	12dM
MP XVIII	COMBINATION LEAD FRONT RIGHT	4cM
MP XIX	COMBINATION LEAD FRONT LEFT	4cP
MP XX	SEAT CROSS MEMBER UNDER THE SEAT RIGHT	8eL

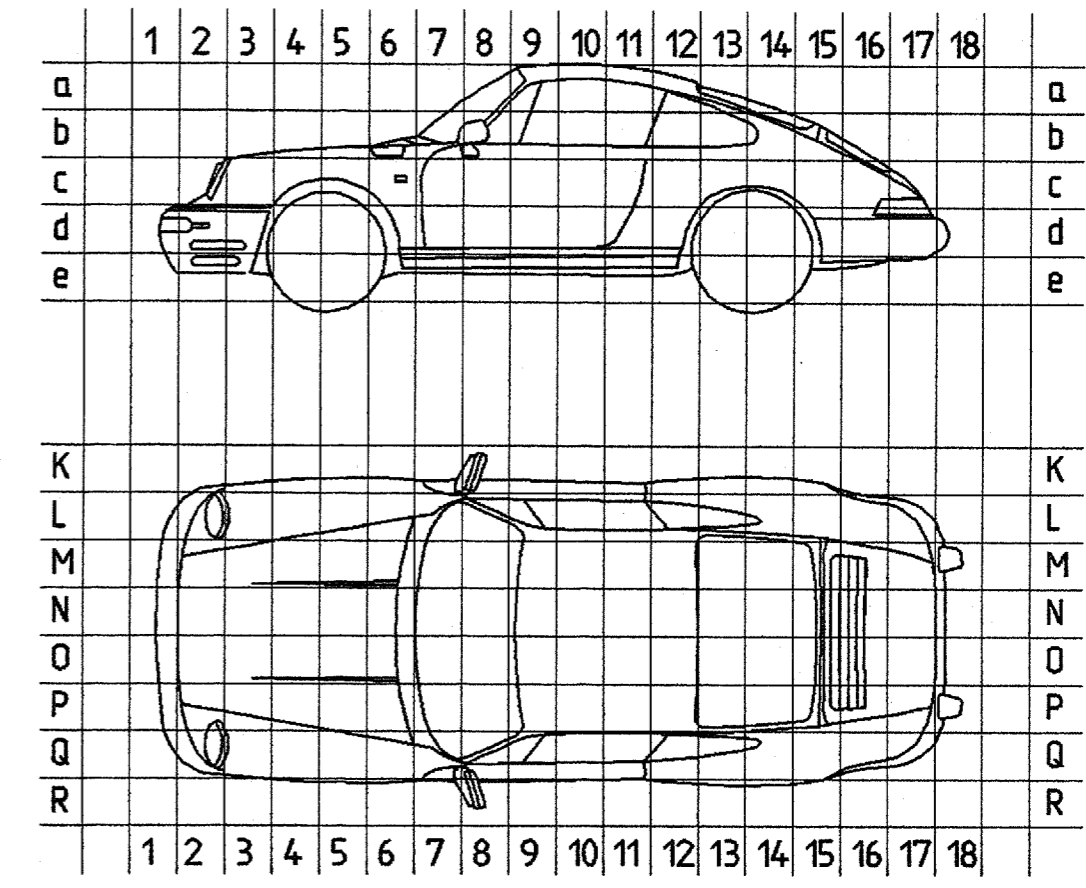

A B C D E F G H J K L M N O P

ADDITIONAL WIRING DIAGRAM TRAILER COUPLING

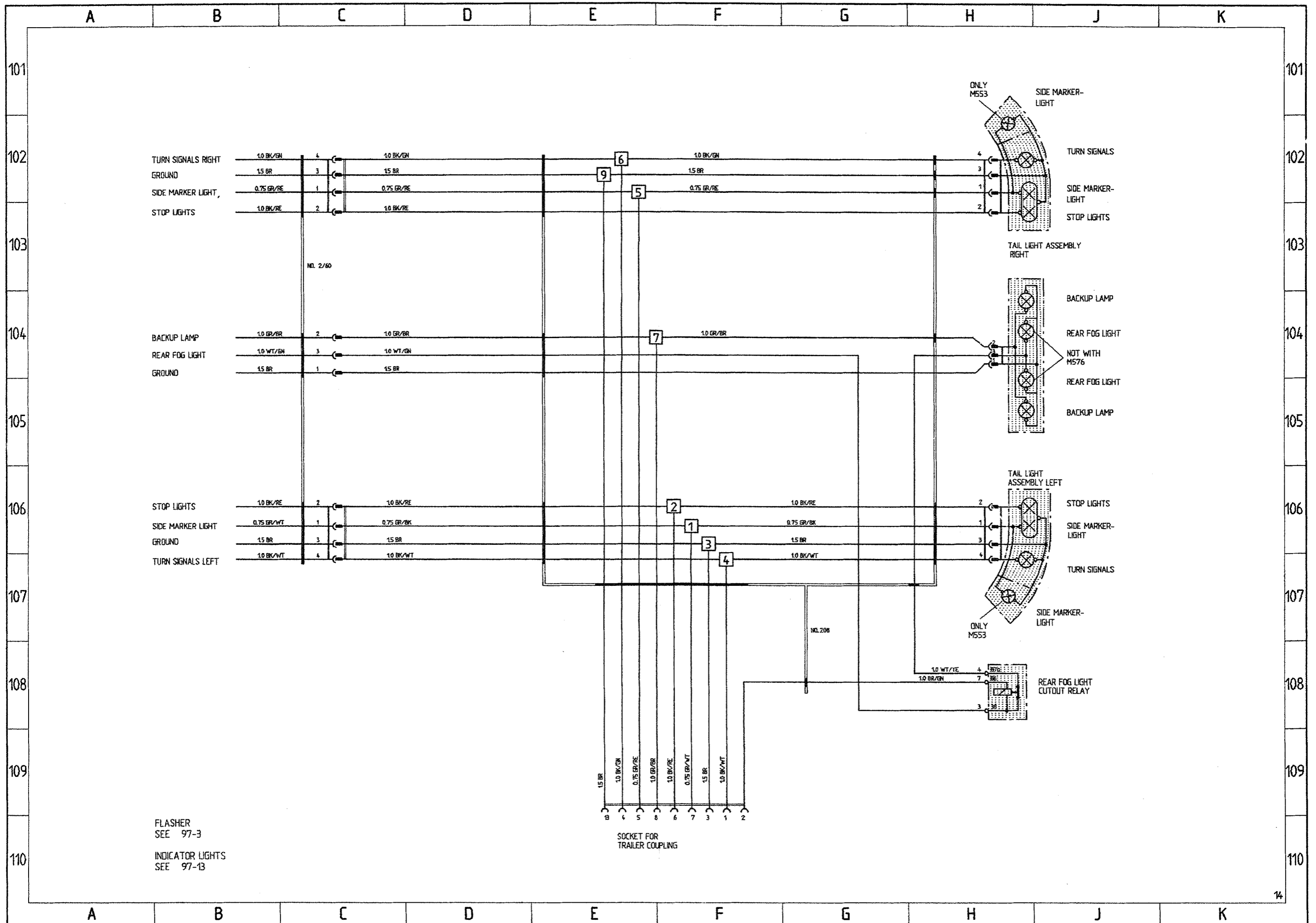

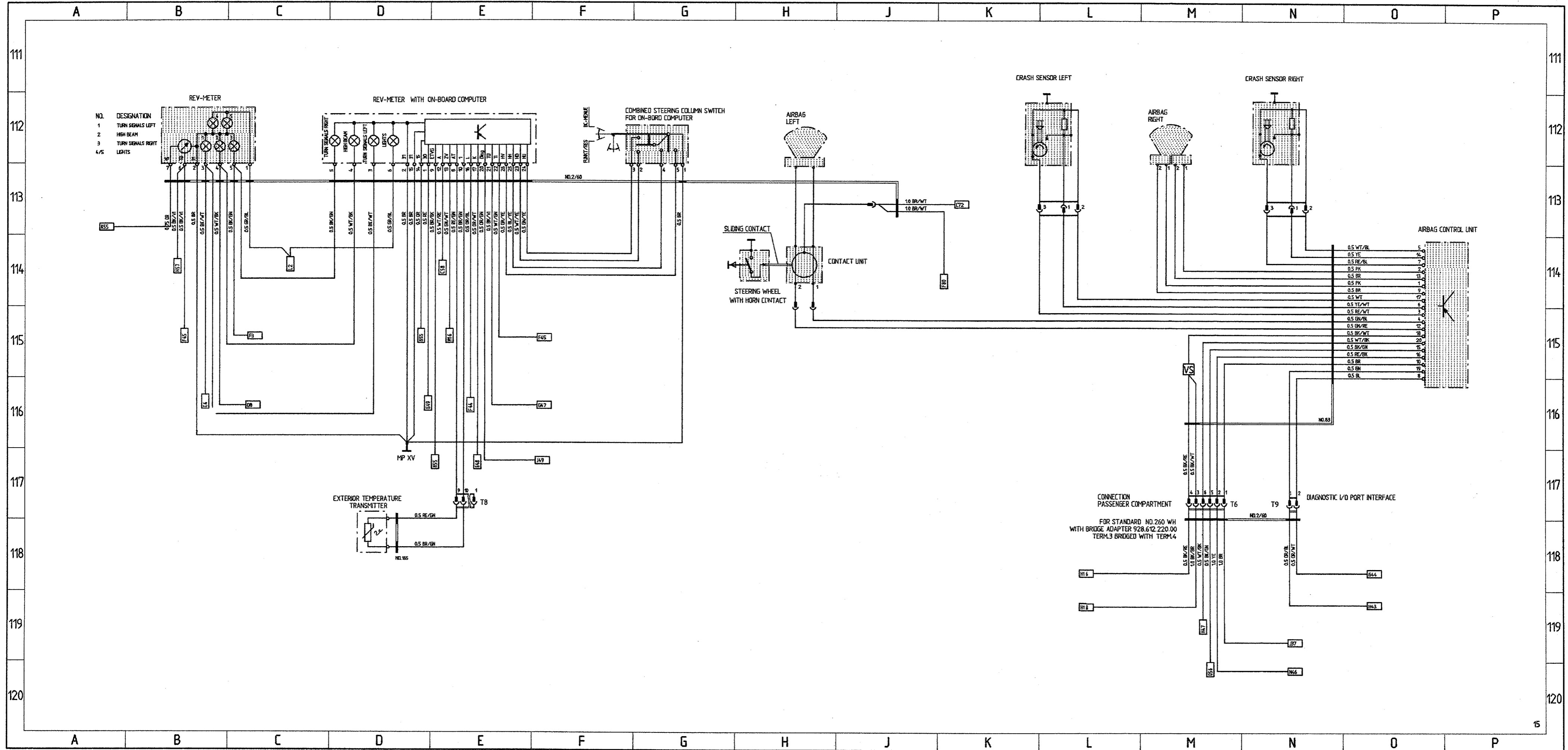

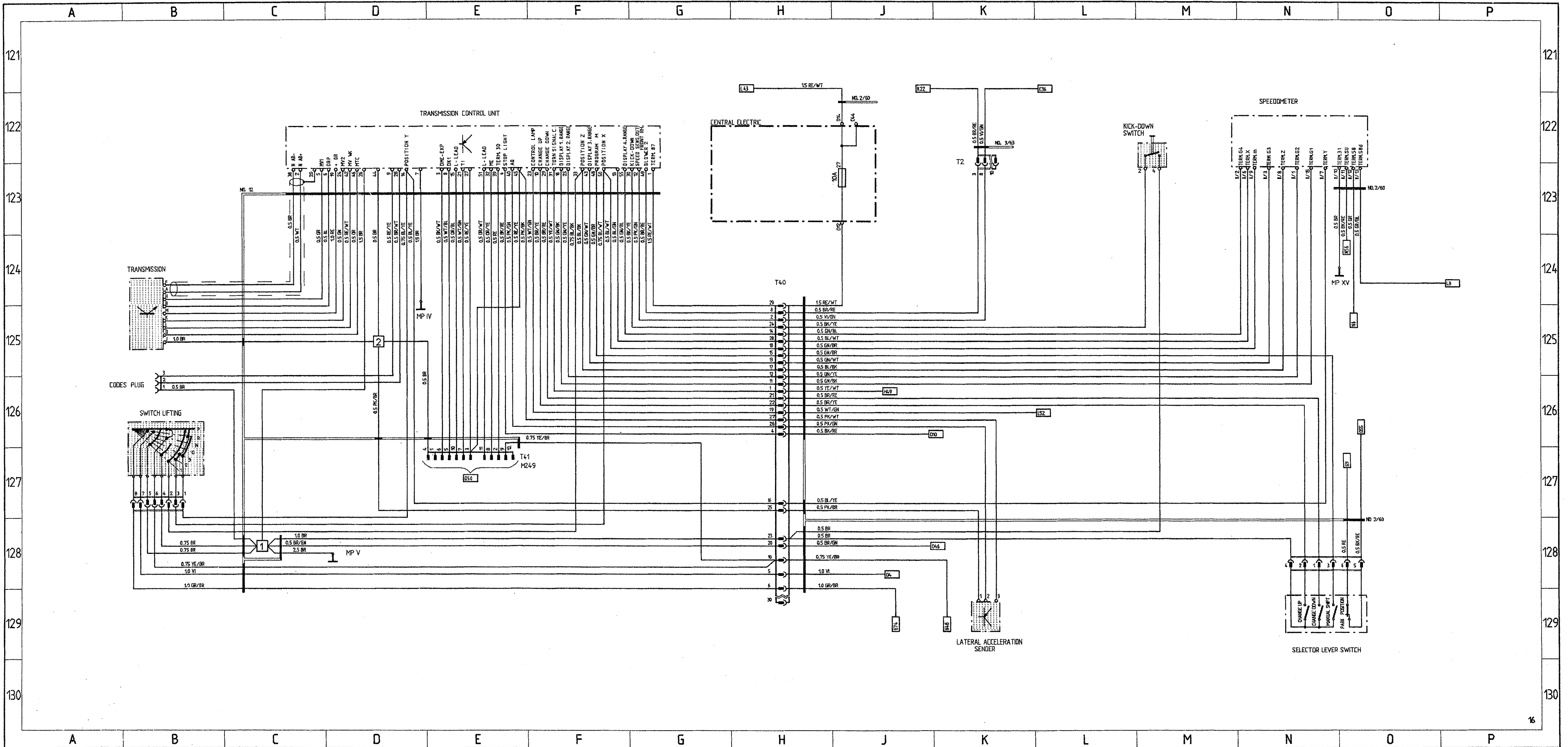

Changes to the circuit diagram for the 911 Carrera 2/4, 1990 model

Sheet 5, D 50

The ground points for the DME control unit are not marked.

2.5 mm² lead, brown, to ground point IV.

1.5 mm² lead, brown, to ground point V.

Sheet 12

Control unit-transmission

The control unit is located beneath the left-hand seat.

Please alter the circuit diagram accordingly.

Wiring Diagram

Type 911 Carrera 2 and 4 Model 91

Coordinates

Sheet 1	1 - 10	Lights
Sheet 2	11 - 20	Alarm System, Central Locks, Mirror, Power Window Regulator, Inside Lights
Sheet 3	21 - 30	Heater, AC, Coolant Fan, Rear Window Defogger
Sheet 4	31 - 40	ABS, Porsche Dynamic AWD Control (Carrera 4)
Sheet 4a	31 - 40	ABS (Carrera 2)
Sheet 5	41 - 50	Motor, Ignition, Cruise Control
Sheet 6	51 - 60	Instruments, Sender, Central Informer, On-board computer
Sheet 7	61 - 70	Seats
Sheet 8	71 - 80	Rear Spoiler, Two-Tone Horns, Wipe- and Wash Cleaners, Sun Roof, Convertible Top
Sheet 9	81 - 90	Radio, Telephone
Sheet 10	91 - 100	Fog Light, Rear Fog Light
Sheet 11		Central Electric
Sheet 12		Construction Components
Sheet 13		Plug Connections, Ground Points, M-Numbers, Abbreviations
Sheet 14	101 - 110	Trailer Coupling
Sheet 15	111 - 120	Airbag
Sheet 16	121 - 130	Tiptronic (Carrera 2)

Wiring Diagram

Type 911 Carrera 2 and 4 Model 91

The wiring diagram consists of *15 individual wiring diagrams*, 1 sheet *construction components* and 1 sheet *plug connections and ground points*. These are divided into coordinate fields.

Each individual wiring diagram contains a part of the central-electrics box in a dashdotted frame.

This part of the central-electrics box shows all the lines and relays necessary for the individual wiring diagram.

The earth/ground points are identified by "MP" and their location is shown in a vehicle diagram.

The 10-pin connectors on the central-electrics box are clipped together out of 3 parts, the 20-pin connectors are clipped together out of 5 parts.

Part 1, with the moduled-on fastening lug, is the "starting element".

Parts 2,3 and 4 are "module elements".

The 10-pin connectors only contents one "module element".

Start- and module elements are identified by the numbers 1.....5.

Part 5 ist a "coding element".

The designations of the plug connections in the wiring diagram refer to the "starting element" from, for example, B 11.....15, and to the first module element from B 21.....25.

LIGHTS

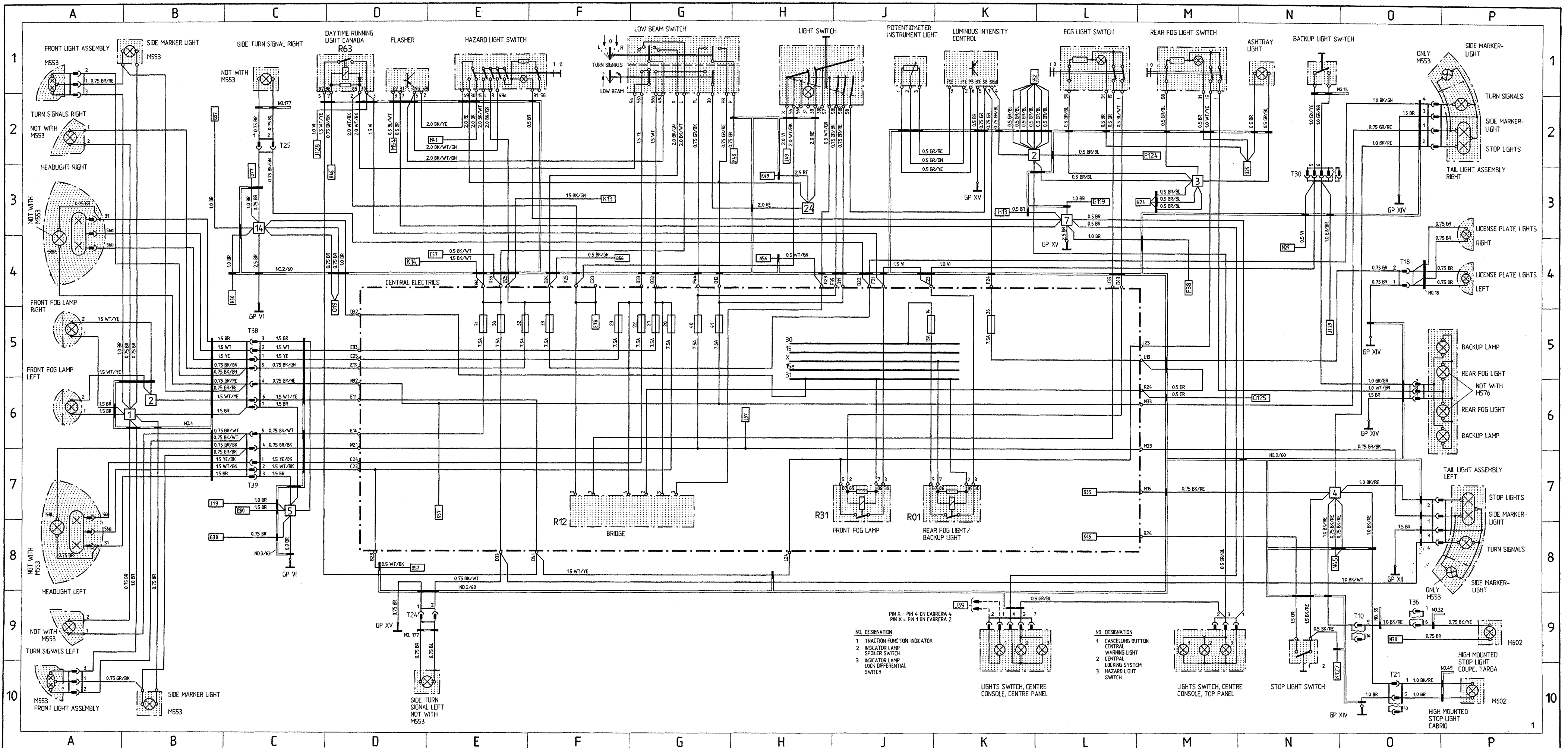

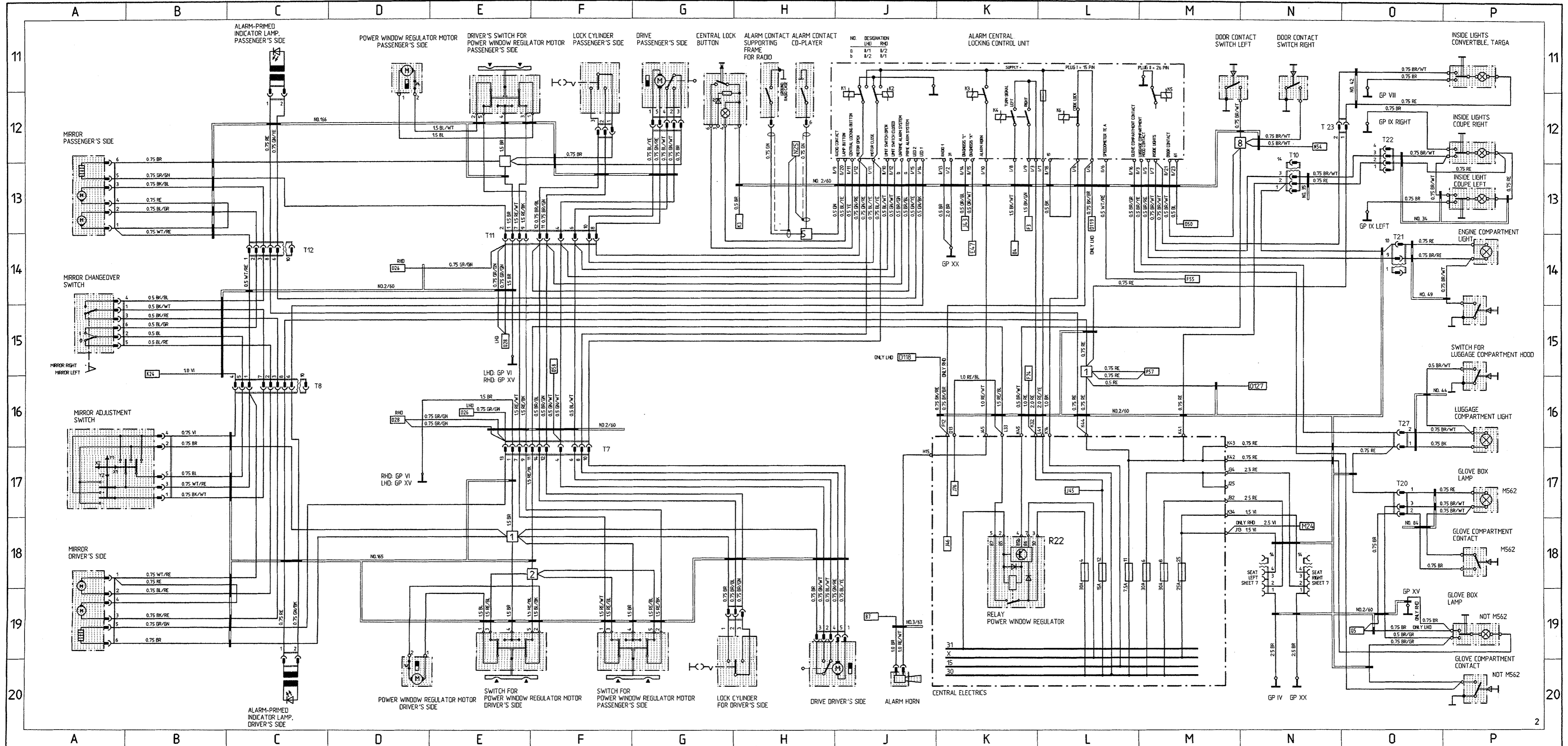

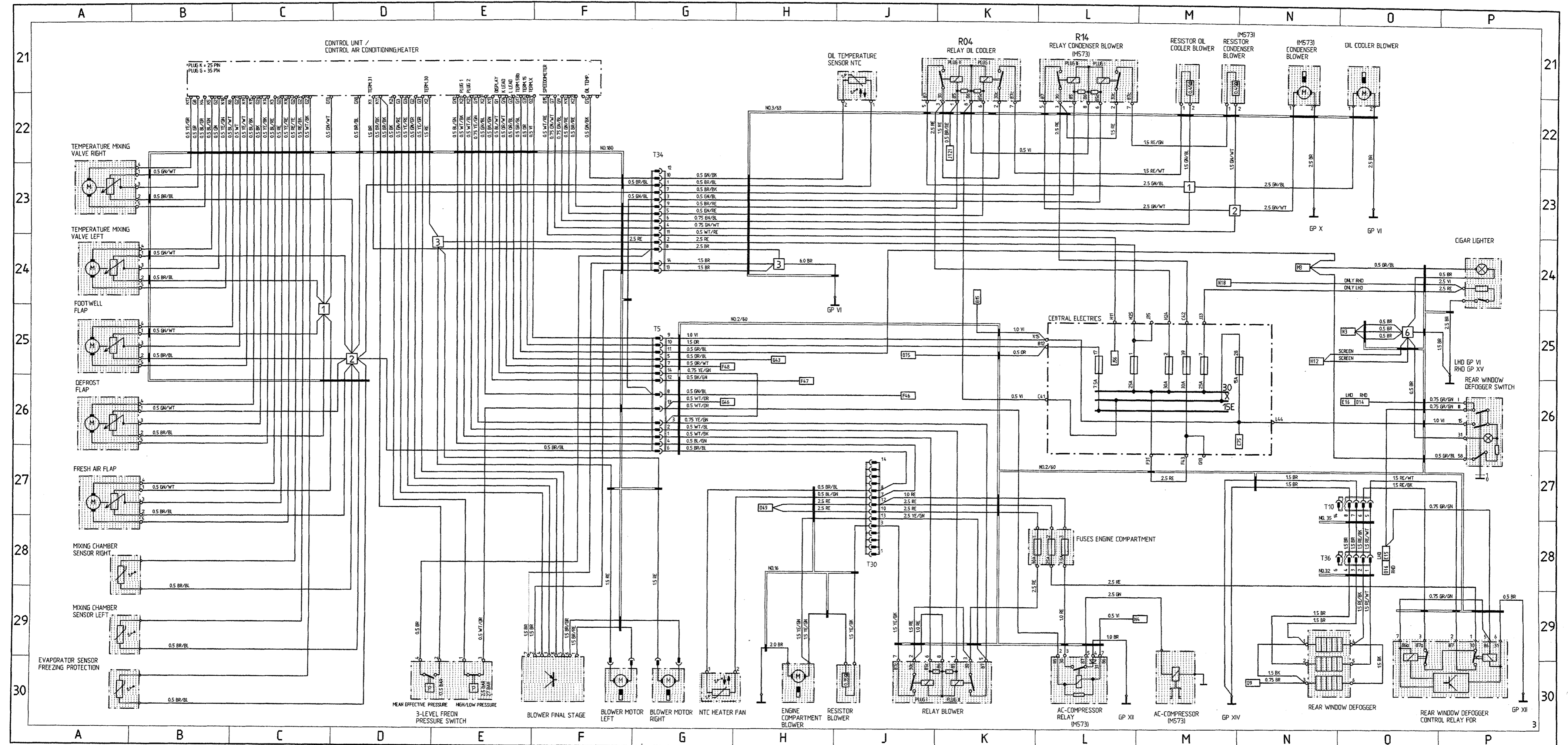

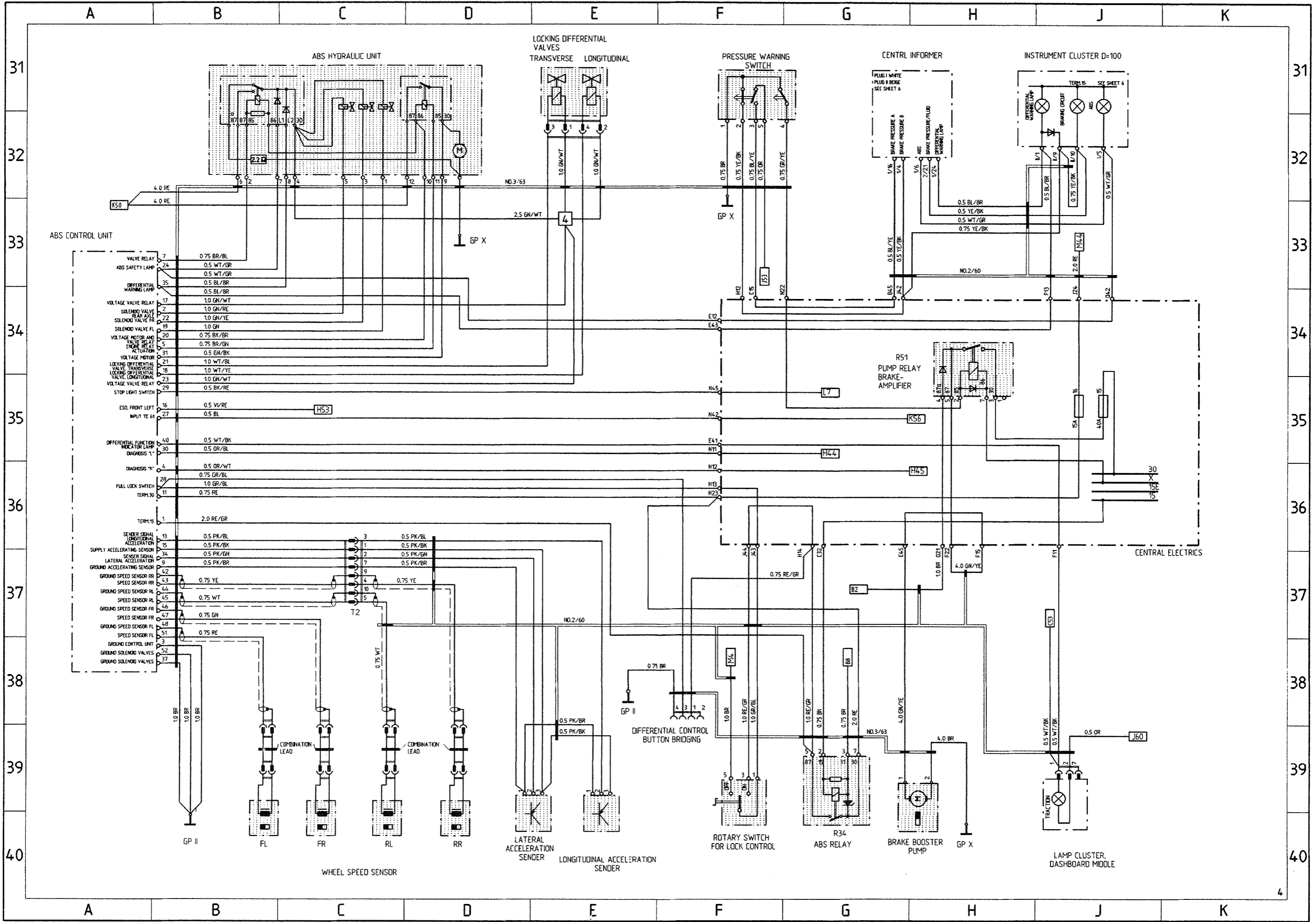

ABS

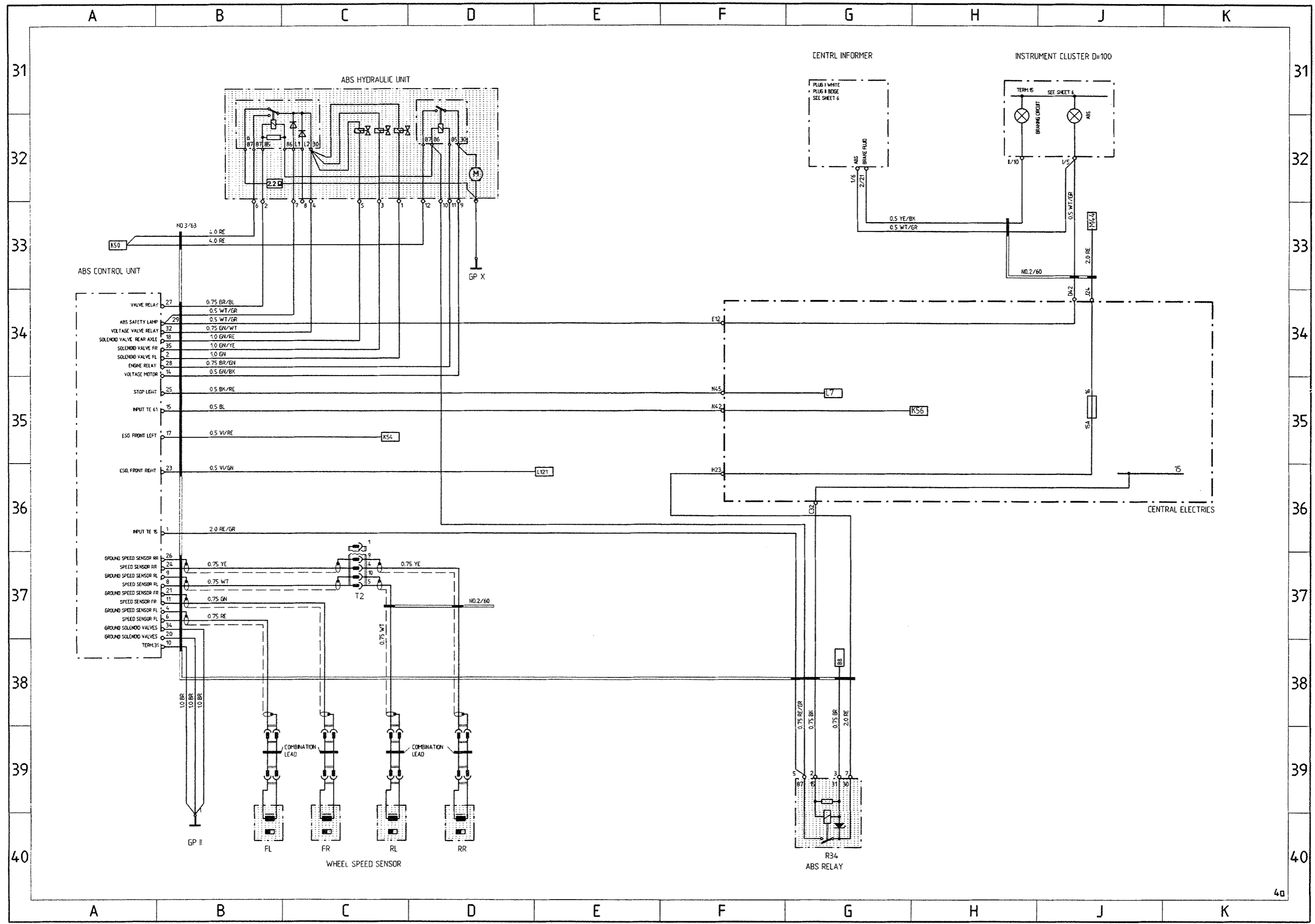

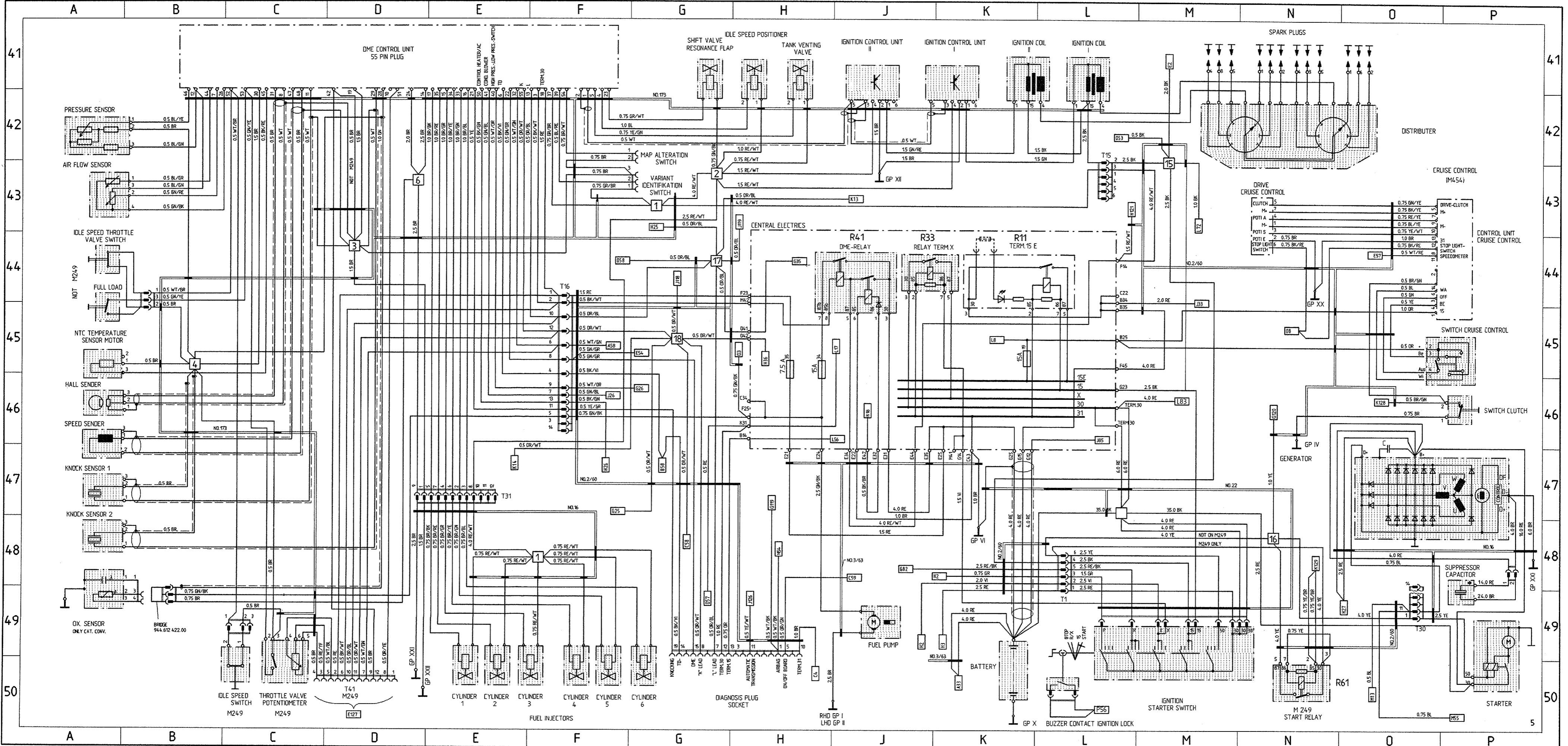

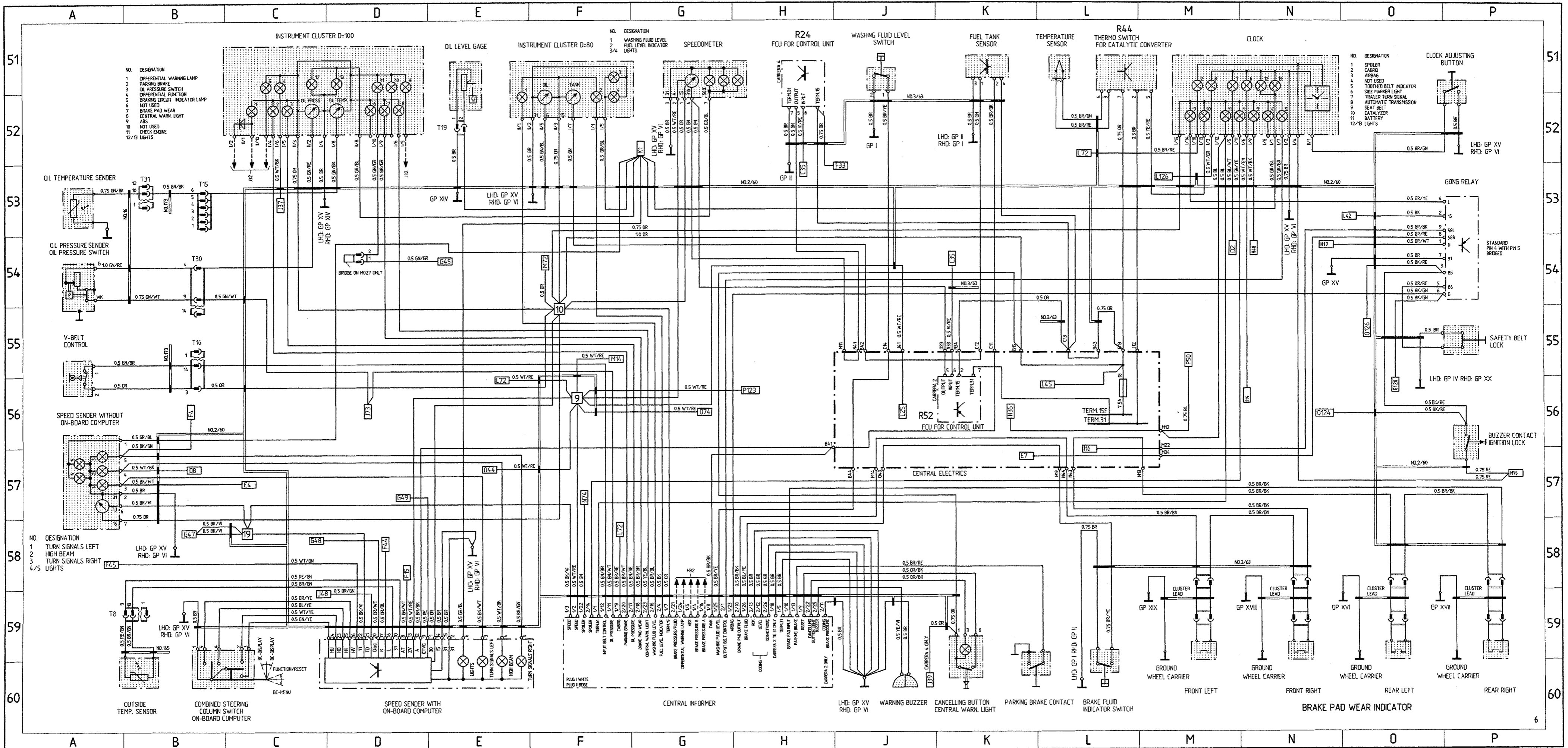

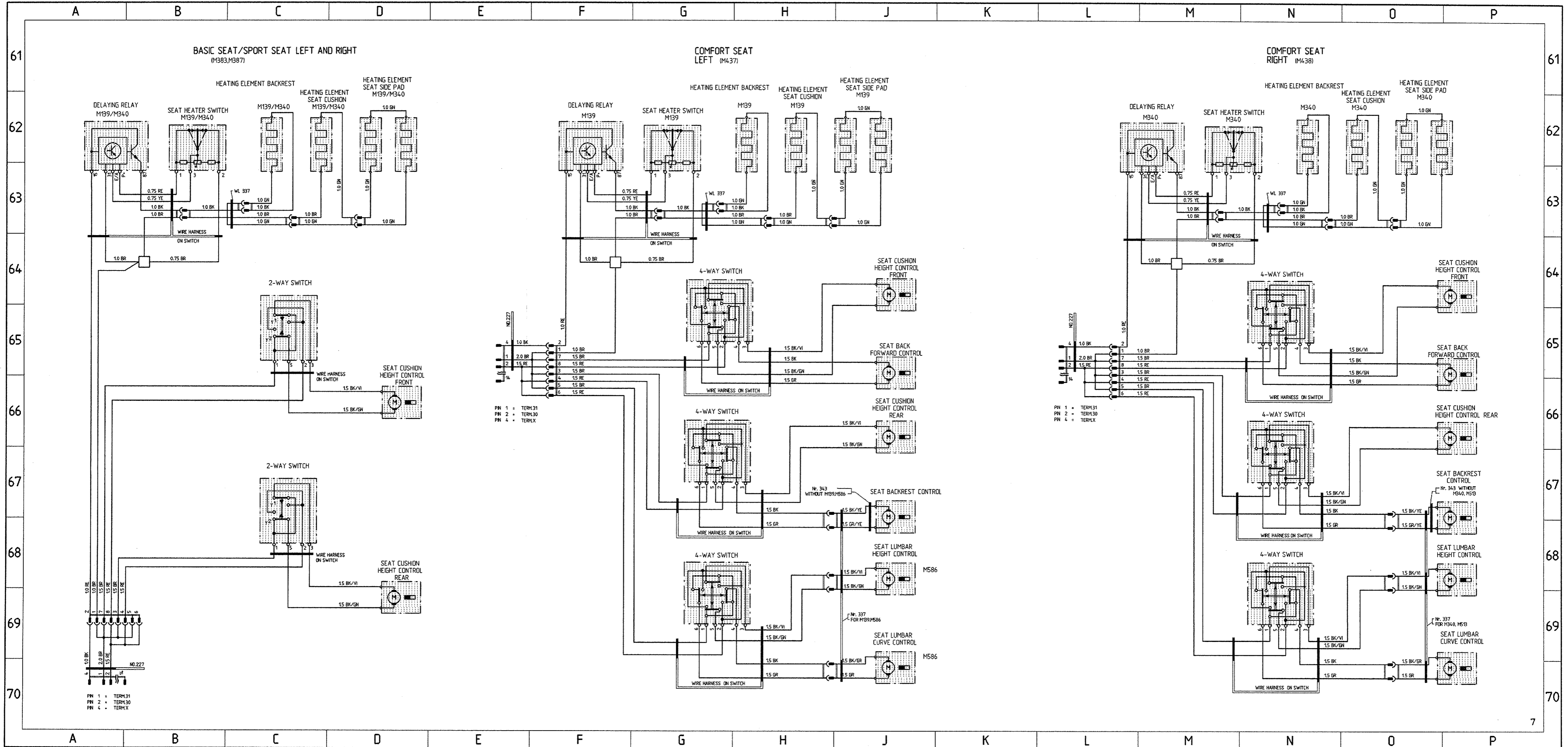

REAR SPOILER, TWO-TONE HORNS, WIPE- AND WASH CLEANERS, SUN ROOF, CONVERTIBLE TOP

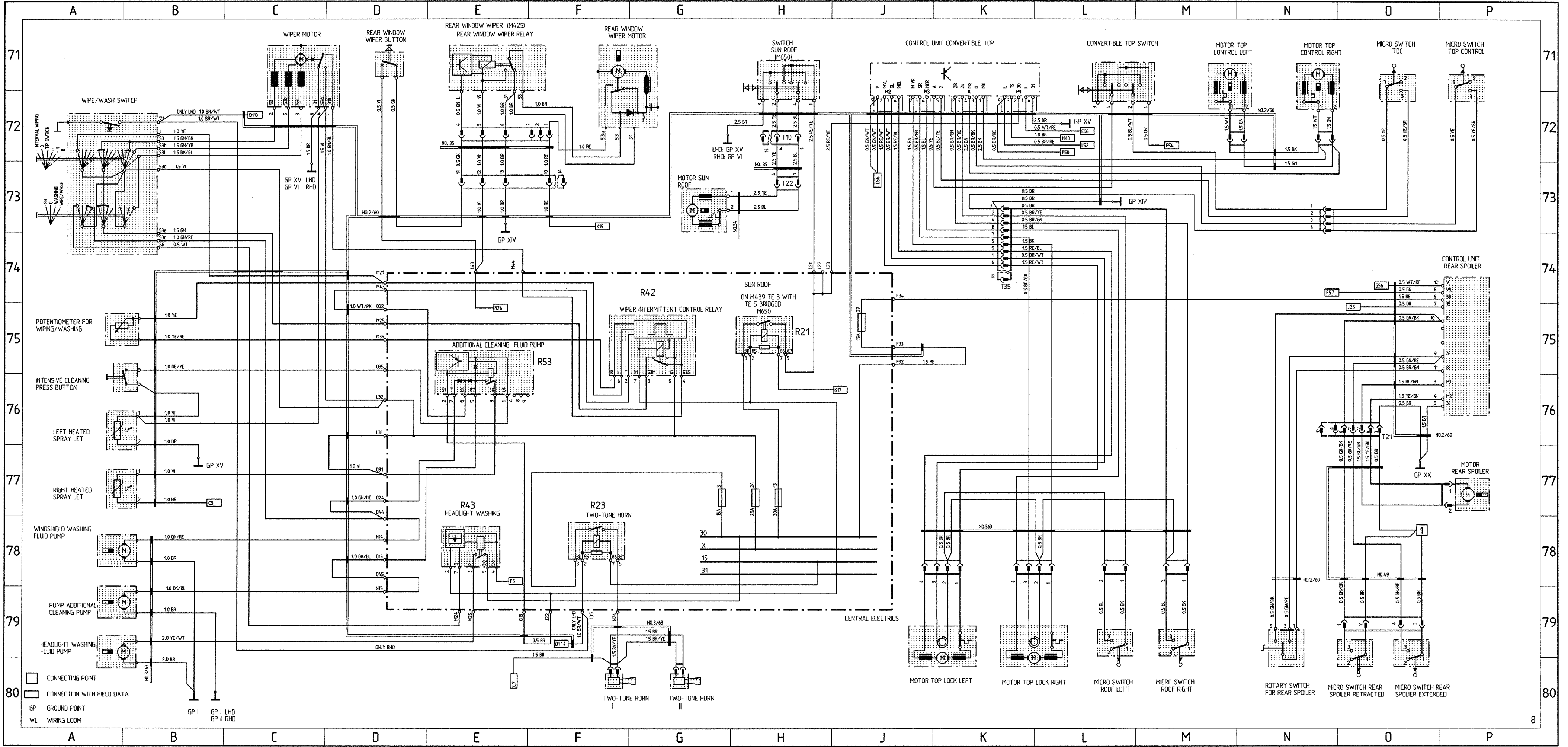

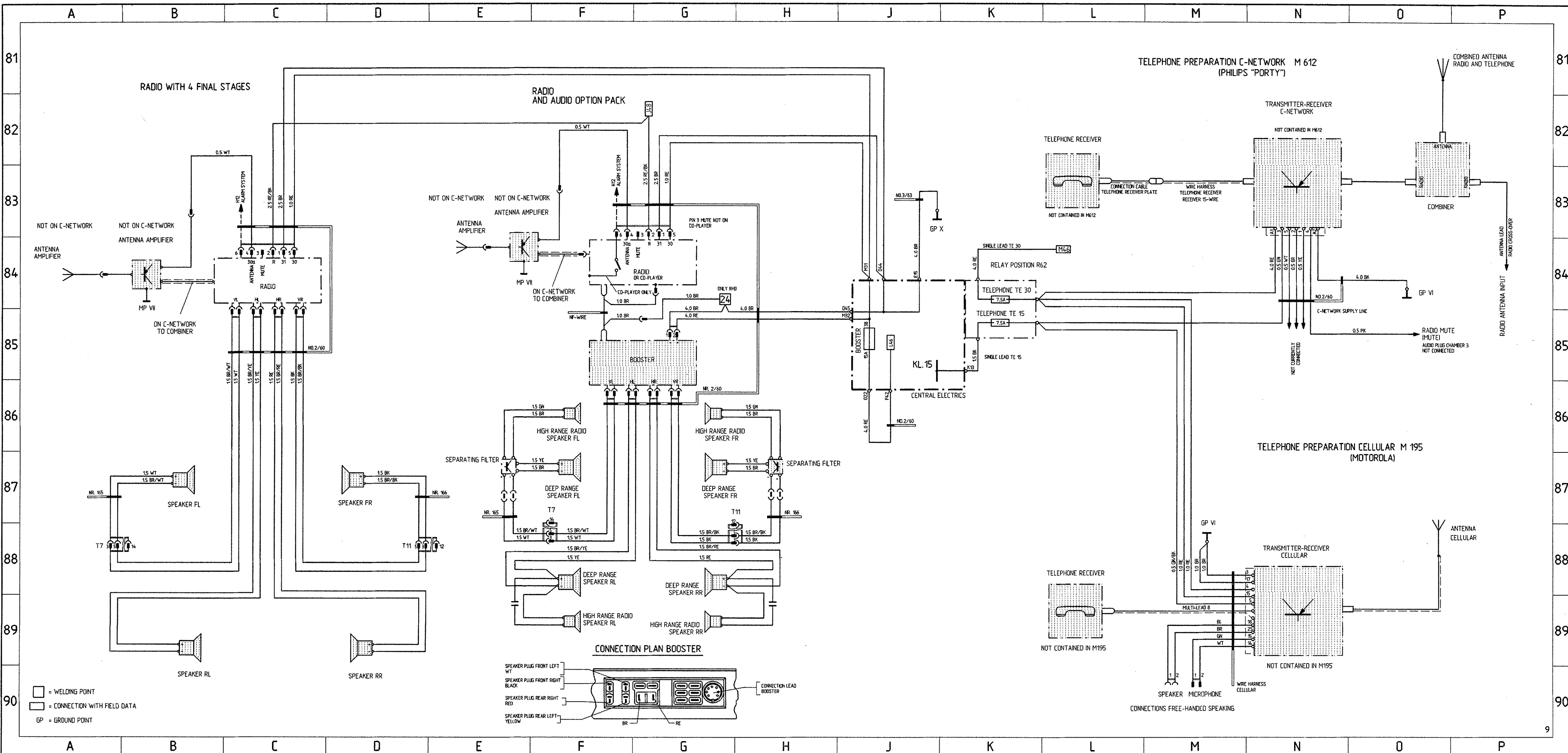

□ = WELDING POINT
 □ = CONNECTION WITH FIELD DATA
 GP = GROUND POINT

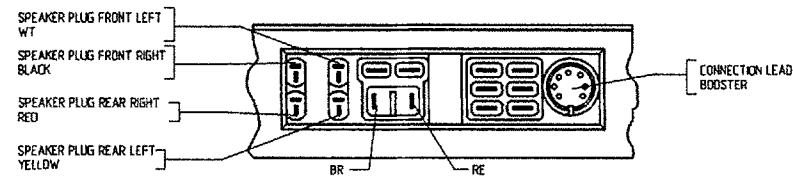

FOG LIGHT, REAR FOG LIGHT

FOG LIGHT- AND REAR FOG LIGHT - WIRINGS

ROW
FOG LIGHT +
REAR FOG LIGHT FROM 58

M487-NORWAY
FOG LIGHT + REAR FOG LIGHT
ONLY WITH 57

M553-USA
FOG LIGHT WITH 56b + 57

M193 JAPAN
FOG LIGHT +
REAR FOG LIGHT FROM 58

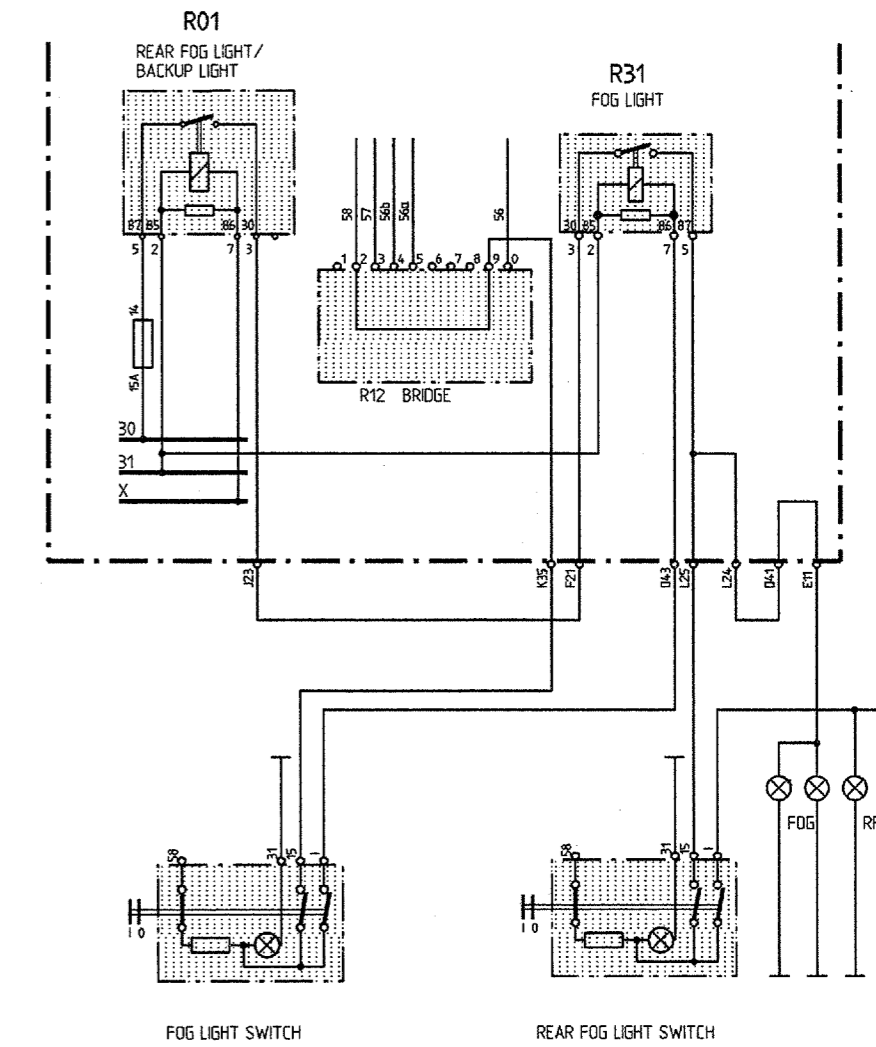
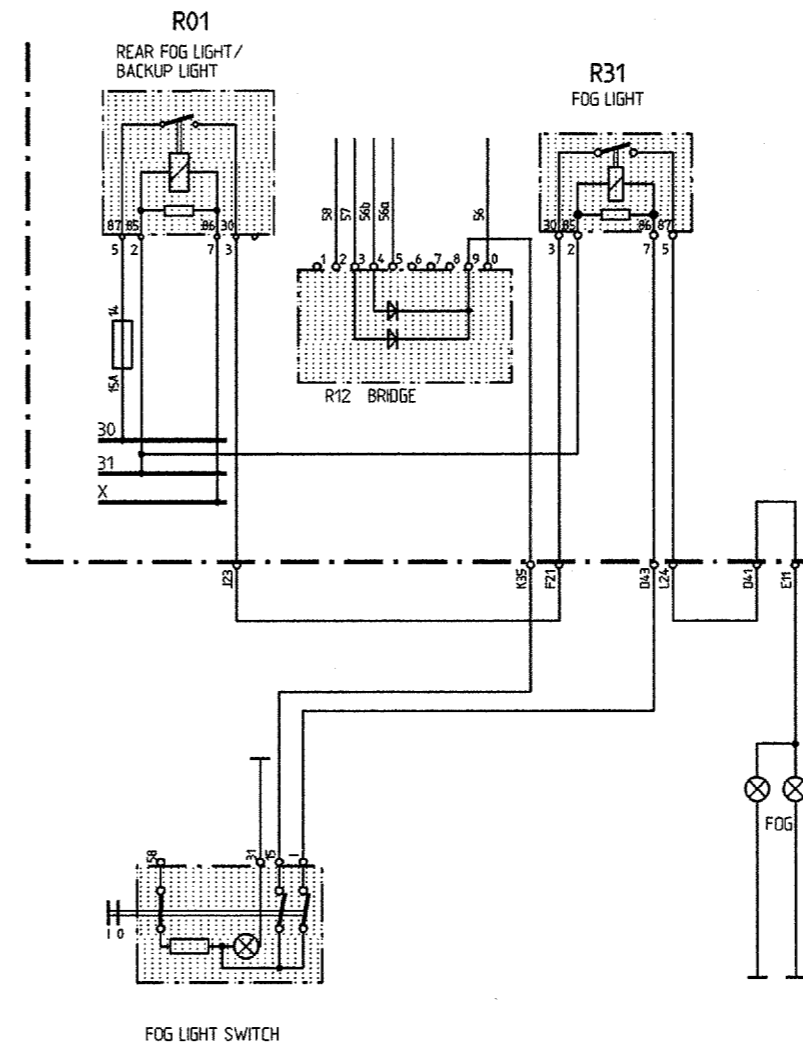
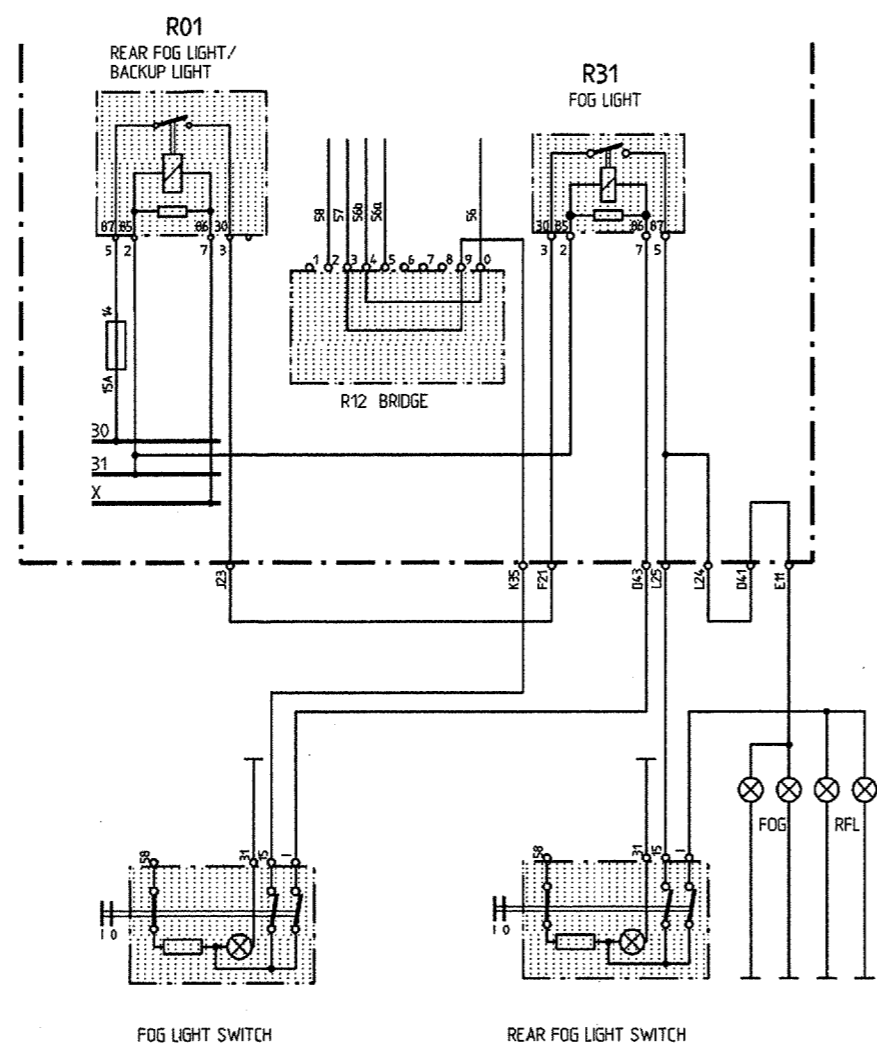
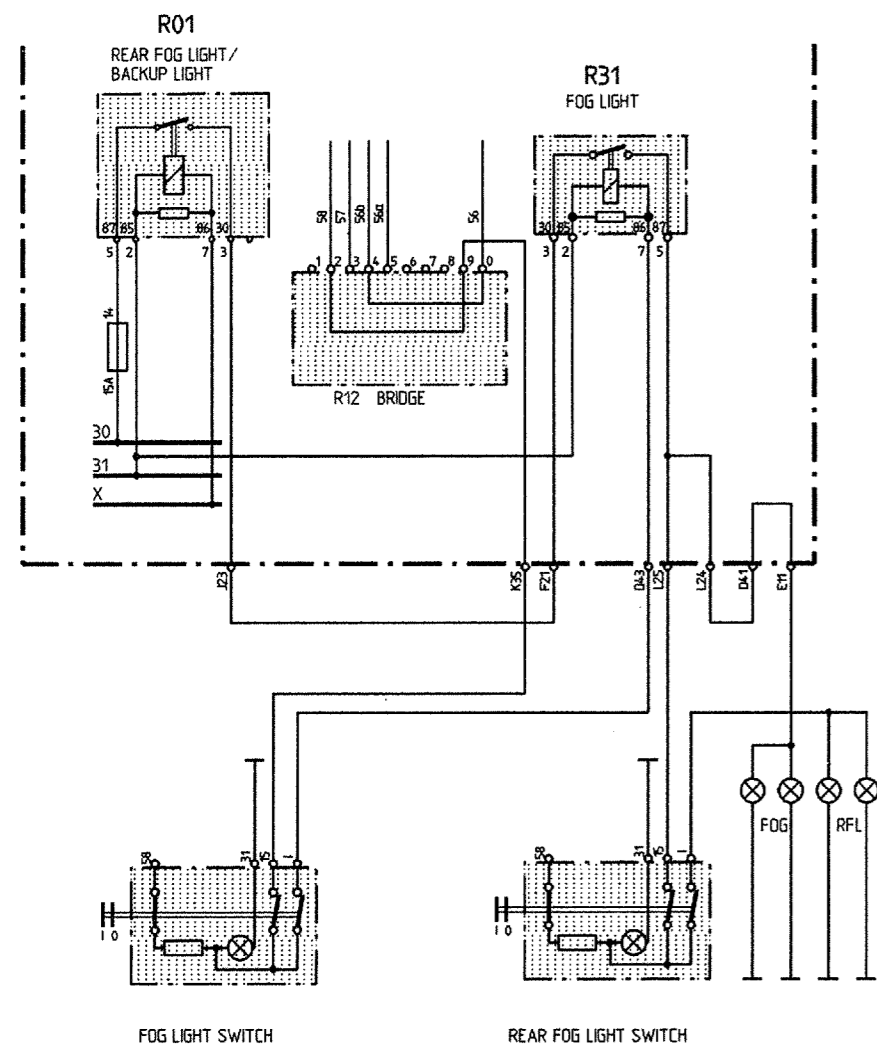

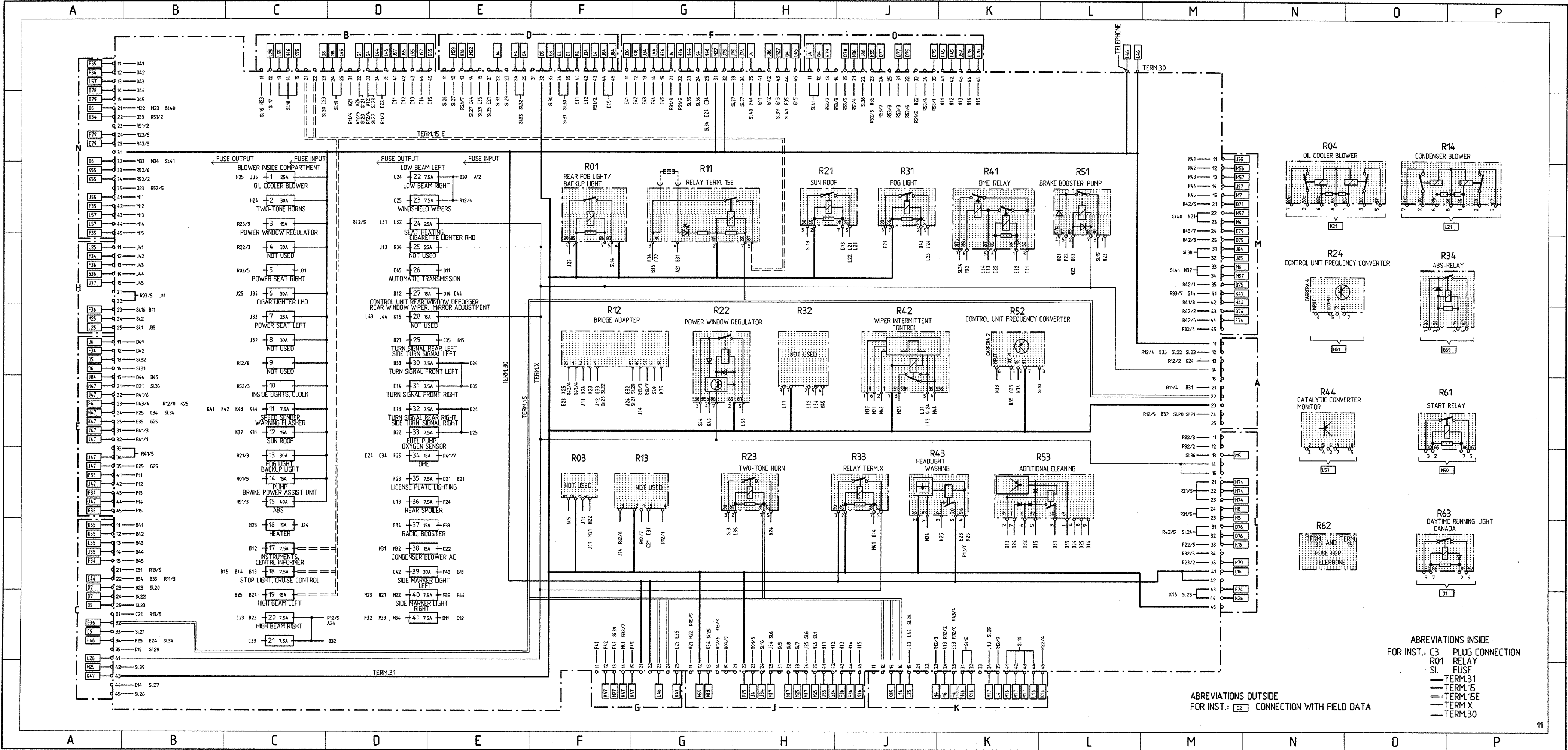

- ABREVIATIONS INSIDE
FOR INST.: C3 PLUG CONNECTION
R01 RELAY
SI FUSE
— TERM.31
— TERM.15
— TERM.15E
— TERM.X
— TERM.30
- ABREVIATIONS OUTSIDE
FOR INST.: E2 CONNECTION WITH FIELD DATA

CONSTRUCTION COMPONENTS

A B C D E F G H J K L M N O P

CONSTRUCTION COMPONENTS

DESIGNATION, FUNCTION	POSITION IN VEHICLE		NOTE	FIELD IN WIRING DIAGRAM
	LHD	RHD		
ABS RELAY	6cM	6cM	CENTRAL ELECTRICS	G39/40
ALARM HORN	3cL	3cL	IN WHEEL HOUSING FRONT RIGHT	J20
ANTENNA AMPLIFIER	7bL	7bQ	IN LUGGAGE COMPARTMENT	B84/E84
OUTSIDE TEMP. SENSOR	8bR	8bK	IN OUTSIDE MIRROR	B60
FLASHER	7dN	7dN	IN CENTRE CONSOLE	D1
BOOSTER	9eM	9eM	UNDER THE SEAT RIGHT	F/G85
STOP LIGHT SWITCH	6dP	6dM	AT THE BRAKE PEDAL BELOW THE FLOOR PANEL	N9
DIAGNOSIS CONNECTION	7cL	7cQ	IN PASSENGER'S FOOTWELL	G/H50
DME RELAY	6cM	6cM	CENTRAL ELECTRICS	J44
DME CONTROL UNIT	9eP	9eP	UNDER THE SEAT LEFT	B-F41
SPEED SENDER	15cP	15cP	BY ENGINE LEFT	A47
THROTTLE VALVE POTENTIOMETER, AUTOM. TRANSMISSION	15bN	15bN	ON THROTTLE VALVE ASSEMBLY	C50
THROTTLE VALVE SWITCH, MANUAL TRANSMISSION	15bN	15bN	ON THROTTLE VALVE ASSEMBLY	A44/45
PRESSURE SENSOR	10eP	10eP	UNDER THE SEAT LEFT	A42
PRESSURE WARNING SWITCH	1dD	1dD	IN LUGGAGE COMPARTMENT	F31
PRESSURE SWITCH AIR CONDITIONING SYSTEM	6bD	—	IN LUGGAGE COMPARTMENT	E30
TWO-TONE HORN I	3cL	3cL	IN WHEEL HOUSING FRONT RIGHT	F80
TWO-TONE HORN II	3cL	3cL	IN WHEEL HOUSING FRONT RIGHT	G80
SEPARATING FILTER FL	9dD	9dQ	UNDER THE DOOR TRIM PANEL	E87
SEPARATING FILTER FR	9dL	9dL	UNDER THE DOOR TRIM PANEL	H87
CRASH SENSOR RIGHT	4cM	—	IN LUGGAGE COMPARTMENT	G112/113
CRASH SENSOR LEFT	4cP	—	IN LUGGAGE COMPARTMENT	E112/113
BLOWER FINAL STAGE	6bN	6bN	IN LUGGAGE COMPARTMENT	F30
BLOWER ENGINE COMPARTMENT	16cD	16cD	ON ENGINE	H30
BLOWER MOTOR RIGHT	6cM	6cM	IN LUGGAGE COMPARTMENT	G30
BLOWER MOTOR LEFT	6cP	6cP	IN LUGGAGE COMPARTMENT	F30
GONG RELAY	6cP	—	BY STEERING COLUMN LEFT	P53/54
HALL SENDER	17cD	17cD	ON DISTRIBUTOR	A46
REAR WINDOW WIPER RELAY	15bD	15bD	ON REAR WINDOW WIPER MOTOR	E71
HYDRAULIC UNIT ABS	3dP	3dP	IN LUGGAGE COMPARTMENT	C32
V-BELT CONTROL	17dD	17dD	ON ENGINE	A55/56
MAP ALTERATION-SWITCH	9eP	9eP	UNDER THE SEAT LEFT	G42
KICK-DOWN SWITCH	6dD	6dM	BY ACCELERATOR PEDAL UNDER FLOOR PANEL	M122
KNOCK SENSOR 1	15cP	15cP	BY ENGINE LEFT	A47
KNOCK SENSOR 2	16cN	16cN	BY ENGINE TOP	A48
CONDENSER BLOWER	2dD	2dQ	IN WHEEL HOUSING FRONT LEFT	N21
FUEL PUMP	6eM	6eP	BEHIND THE BASE	J49
CLUTCH SWITCH CRUISE CONTROL	6dP	6dN	BY CLUTCH PEDAL UNDER FLOOR PANEL	P46
LONGITUDINAL ACCELERATION SENDER	7dN	7dN	IN CENTRE CONSOLE	E40
LOCKING DIFFERENTIAL VALVES LONGIT. AND TRANSVERSE	3dM	3dM	IN LUGGAGE COMPARTMENT	E31
IDLE SPEED SWITCH AUTOMATIC TRANSMISSION	15bN	15bN	ON ENGINE	C50
IDLE SPEED POSITIONER	15bN	15bN	IN ENGINE COMPARTMENT	H41
AIR FLOW SENSOR	16bD	16bD	ON ENGINE	A43
MICRO SWITCH ROOF RIGHT	9aD	9aD	AT CONVERTIBLE TOP FRAME	M79
MICRO SWITCH ROOF LEFT	9aD	9aD	AT CONVERTIBLE TOP FRAME	L79
MICRO SWITCH REAR SPOILER EXTENDED	16bP	16bP	ON TAILGATE	O79
MICRO SWITCH REAR SPOILER RETRACTED	16bP	16bP	ON TAILGATE	O79
MICRO SWITCH TDC	12cL	12cL	BEHIND SIDE PANEL COVERING	O71
MICROSWITCH FOR TOP CONTROL	12cL	12cL	BEHIND SIDE PANEL COVERING	P71
MOTOR SUN ROOF	12aD	12aD	IN ROOF	G73
MOTOR TOP CONTROL RIGHT	15cN	15cN	BEHIND REAR SEAT	N71
MOTOR TOP CONTROL LEFT	15cD	15cD	BEHIND REAR SEAT	M71
MOTOR TOP LOCK RIGHT	9aD	9aD	AT CONVERTIBLE TOP FRAME	K/L79
MOTOR TOP LOCK LEFT	9aD	9aD	AT CONVERTIBLE TOP FRAME	J/K79
REAR FOG LIGHT CUTOFF RELAY	17dN	17dN	BEHIND REAR PANEL	A108
NTC HEATER FAN	16cP	16cP	IN ENGINE COMPARTMENT	G30
OIL PRESSURE SENDER/SWITCH	14cN	14cN	ON ENGINE	A54
OIL COOLER BLOWER	2dL	2dL	IN WHEEL HOUSING FRONT RIGHT	O21
OIL LEVEL GAGE	12cK	12cK	IN WHEEL HOUSING REAR RIGHT	E51/52

DESIGNATION, FUNCTION	POSITION IN VEHICLE		NOTE	FIELD IN WIRING DIAGRAM
	LHD	RHD		
OIL TEMPERATURE SENDER FOR INSTRUMENT	14cN	14cN	ON ENGINE	A53
OIL TEMPERATURE SENDER FOR OIL COOLER BLOWER	2dL	2dL	IN WHEEL HOUSING FRONT RIGHT	J21
SWITCH LIFTING	12dD	12dD	ON GEARBOX	D-F129
BRAKE BOOSTER PUMP	1dD	1dD	IN LUGGAGE COMPARTMENT	H39/40
LATERAL ACCELERATION SENDER ABS	7dN	7dN	IN CENTRE CONSOLE	D40
LATERAL ACCELERATION SENDER AUTOMATIC TRANSMISSION	7dN	7dN	IN CENTRE CONSOLE	K129
CONTROL RELAY REAR WINDOW DEFOGGER	16cP	16cP	CARRIER PLATE IN ENGINE COMPARTMENT	O/P29/30
RELAY CONDENSER BLOWER	6cM	6cM	CENTRAL ELECTRICS	L21
RELAY AC COMPRESSOR	16cP	16cP	CARRIER PLATE IN ENGINE COMPARTMENT	L30
RELAY TWO-TONE HORN	6cM	6cM	CENTRAL ELECTRICS	F78
RELAY POWER WINDOW REGULATOR	6cM	6cM	CENTRAL ELECTRICS	K18/19
RELAY FREQUENCY TRANSFORMER	6cM	6cM	CENTRAL ELECTRICS	K56/H51
RELAY BLOWER ENGINE COMPARTMENT	16cP	16cP	CARRIER PLATE IN ENGINE COMPARTMENT	J/K30
RELAY STARTER AUTOMATIC TRANSMISSION	6cM	6cM	CENTRAL ELECTRICS	N50
RELAY ADDITIONAL CLEANING FLUID PUMP	6cM	6cM	CENTRAL ELECTRICS	E75/76
RELAY THERMO SWITCH CATALYTIC CONVERTER	6cM	6cM	CENTRAL ELECTRICS	L/M51
RELAY TERM.X	6cM	6cM	CENTRAL ELECTRICS	K44
RELAY TERM.15 E	6cM	6cM	CENTRAL ELECTRICS	K/L44
RELAY REAR FOG LIGHT- BACKUP LIGHT	E87	6cM	CENTRAL ELECTRICS	J/K7
RELAY FRONT FOG LAMP	6cM	6cM	CENTRAL ELECTRICS	J7
RELAY OIL COOLER BLOWER	6cM	6cM	CENTRAL ELECTRICS	K21
RELAY BRAKE BOOSTER PUMP	6cM	6cM	CENTRAL ELECTRICS	H34/35
RELAY SUN ROOF	6cM	6cM	CENTRAL ELECTRICS	H75
RELAY STARTER DAYTIME RUNNING LIGHT CANADA	6cM	6cM	CENTRAL ELECTRICS	D1
BACKUP LIGHT SWITCH	14dN	14dN	BY TRANSMISSION RIGHT	N1
SHIFT VALVE RESONANCE FLAP	15bN	15bN	ON ENGINE	G41
WINDSHIELD WASHING FLUID PUMP	3cQ	3cQ	BY WASHING FLUID RESERVOIR IN WHEEL HOUSING FL	A78
FUSES ENGINE COMPARTMENT	16cP	16cP	CARRIER PLATE IN ENGINE COMPARTMENT	L28
HEADLIGHT CLEANER PUMP	3cQ	3cQ	BY WASHING FLUID RESERVOIR IN WHEEL HOUSING FL	A79/80
HEADLIGHT CLEANER RELAY	6cM	6cM	CENTRAL ELECTRICS	E78
STARTER	14dN	14dN	BY CLUTCH HOUSING RIGHT	P49/50
DRIVE CRUISE CONTROL	15cD	15cD	ON ENGINE	N43/44
CONTROL UNIT ABS	2dM	2dM	IN LUGGAGE COMPARTMENT	A33-38
CONTROL UNIT AIRBAG	6cD	—	ON INSTRUMENT PANEL	J114/115
CONTROL UNIT ALARM SYSTEM/CENTRAL LOCKING SYSTEM	9eM	9eM	UNDER THE SEAT RIGHT	J-M12
CONTROL UNIT AUTOMATIC TRANSMISSION	10dP	10dP	UNDER THE SEAT LEFT	C-G122
CONTROL UNIT CONVERTIBLE TOP	6cP	6cM	ON INSTRUMENT PANEL	J/K71
CONTROL UNIT INSTRUMENT LIGHT	7bQ	7bQ	IN LUGGAGE COMPARTMENT LEFT	K1
CONTROL UNIT REAR SPOILER	9eN	9eN	UNDER THE SEAT RIGHT	P74-76
CONTROL UNIT HEATING, AIR CONDITIONING	7cD	7cN	ON INSTRUMENT PANEL	B-F21
CONTROL UNIT CRUISE CONTROL	9eN	9eN	UNDER THE SEAT RIGHT	P43/44
BUZZER CONTACT	7cP	7cM	ON IGNITION LOCK	P56
FUEL LEVEL SENDER	5cM	5cP	IN FUEL TANK	K51
TANK VENTING VALVE	15cN	15cN	BY ENGINE TOP	H41
TEMPERATURE MOTOR	15cP	15cP	BY ENGINE LEFT	A45
VARIANT IDENTIFICATION SWITCH	9eP	9eP	UNDER THE SEAT LEFT	G43
RESISTOR BLOWER	16dP	16dP	IN ENGINE COMPARTMENT	J30
RESISTOR FOR BLOWER CONDENSER	2dQ	2dQ	IN WHEEL HOUSING FRONT LEFT	M21
RESISTOR OIL COOLER BLOWER	2dL	2dL	IN WHEEL HOUSING FRONT RIGHT	M21
WARNING BUZZER	7cP	7cP	ON INSTRUMENT PANEL	J60
WIPER INTERMITTENT CONTROL RELAY	6cM	6cM	CENTRAL ELECTRICS	F/G75
CENTRAL ELECTRICS	6cM	6cM	IN LUGGAGE COMPARTMENT	—
CENTRAL INFORMER	6cP	6cP	ON STEERING COLUMN	H32,F/G/H59
IGNITION CONTROL UNIT I	15cP	15cP	IN ENGINE COMPARTMENT LEFT	K41
IGNITION CONTROL UNIT II	15cP	15cP	IN ENGINE COMPARTMENT LEFT	J41
IGNITION COIL I	15cQ	15cQ	IN ENGINE COMPARTMENT LEFT	L41
IGNITION COIL II	15cQ	15cQ	IN ENGINE COMPARTMENT LEFT	K41
ADDITIONAL CLEANING FLUID PUMP	4cM	4cQ	IN LUGGAGE COMPARTMENT	A79

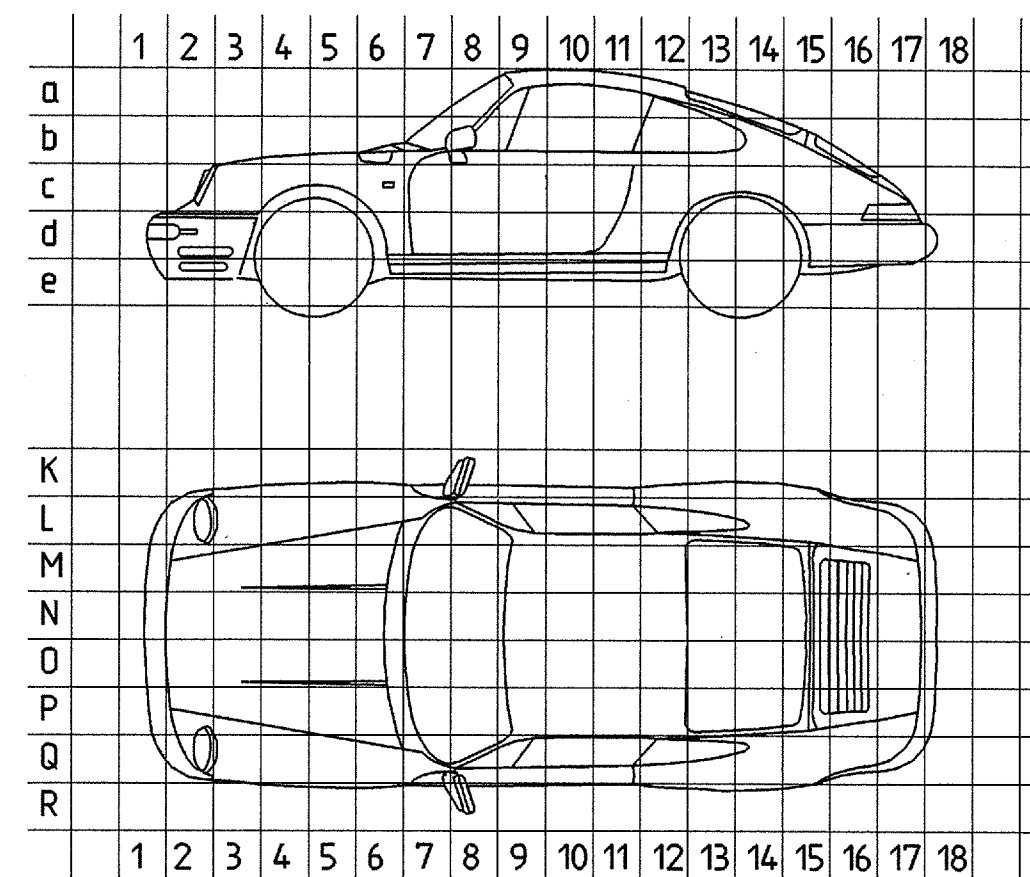

A B C D E F G H J K L M N O P

PLUG CONNECTIONS, GROUND POINTS, ABBREVIATIONS

PLUG CONNECTIONS

CODE	NUMBER OF PINS	DESIGNATION, FUNCTION	POSITION IN VEHICLE		NOTE	FIELD
			LEFT-HAND DRIVE	RIGHT-HAND DRIVE		
T1	6	IGNITION LOCK	6cP	6cM	BY STEERING COLUMN LEFT	L48
T2	10	ABS	6cL	6cL	IN LUGGAGE COMPARTMENT RIGHT	C36/37, K122
T5	14	HEATER, AIR CONDITIONER	6cM	6cM	UNDER INSTRUMENT PANEL RIGHT	G25/26
T6	6	AIRBAG	7dN	7dN	IN CENTRE CONSOLE	F/G117
T7	14	DOOR DRIVER'S SIDE	6cQ	6cL	UNDER INSTRUMENT PANEL LEFT	A88.F88.E/F17
T8	10	DOOR DRIVER'S SIDE	6cQ	6cL	UNDER INSTRUMENT PANEL LEFT	C16.B59
T9	2	AIRBAG	7dN	7dN	IN CENTRE CONSOLE	G117
T10	14	REAR WINDOW SHELF	12cL	12cL	BEHIND SIDE PANEL COVERING	O9.M13.D27.E/F73.H72
T11	12	DOOR PASSENGER'S SIDE	6cL	6cQ	UNDER INSTRUMENT PANEL RIGHT	E14.D88.H88
T12	10	DOOR PASSENGER'S SIDE	6cL	6cQ	UNDER INSTRUMENT PANEL RIGHT	C14
T15	6	DME	9eP	9eP	UNDER THE SEAT LEFT	L43.C14.B53
T16	14	DME	9eP	9eP	UNDER THE SEAT LEFT	F45/46.B55
T18	2	LICENSE PLATE LIGHTS	17dL	17dL	TAIL LIGHTS RIGHT	04
T19	2	OIL LEVEL GAGE	15cM	15cM	IN ENGINE COMPARTMENT RIGHT	E52
T20	3	GLOVE BOX LAMP, AIRBAG	6cL	---	UNDER INSTRUMENT PANEL RIGHT	D17
T21	10	TAILGATE	15cL	15cL	IN ENGINE COMPARTMENT RIGHT	N76.O13.O10
T22	4	INSIDE LIGHTS, SUN ROOF	15bM	15bM	BELOW THE PARCEL TRAY	H73.O12
T23	2	INSIDE LIGHTS CONVERTIBLE, TARGA	6cQ	6cQ	UNDER INSTRUMENT PANEL LEFT	D12
T24	2	SIDE TURN SIGNAL LEFT	7bQ	7bQ	IN LUGGAGE COMPARTMENT ON SIDE MEMBER LEFT	D/E9
T25	2	SIDE TURN SIGNAL RIGHT	7bL	7bL	IN LUGGAGE COMPARTMENT ON SIDE MEMBER RIGHT	C2
T27	2	LUGGAGE COMPARTMENT LIGHT	7bL	7bL	IN LUGGAGE COMPARTMENT ON SIDE MEMBER RIGHT	O16
T30	14	NO. 16 MOTOR	16cP	16cP	CARRIER PLATE IN ENGINE COMPARTMENT	N/03.J27/28.O48/49.B54
T31	12	MOTOR, DME	16cP	16cP	CARRIER PLATE IN ENGINE COMPARTMENT	D/E47.B53
T34	14	HEATER, AIR CONDITIONER	6cM	6cM	IN LUGGAGE COMPARTMENT RIGHT	G23/24
T35	12	CONVERTIBLE TOP	12cL	12cL	BEHIND SIDE PANEL COVERING	K73/74
T36	6	REAR WINDOW	15bM	15bM	BELOW THE PARCEL TRAY	O9.O28
T38	7	NO.4, FRONT LIGHTS	3cL	3cL	IN WHEEL HOUSING FRONT RIGHT	C5/6
T39	5	NO.4, FRONT LIGHTS	3cL	3cL	IN WHEEL HOUSING FRONT RIGHT	C6/7
T40	30	AUTOMATIC TRANSMISSION	9eP	9eP	UNDER THE SEAT LEFT	H124/125
T41	12	AUTOMATIC TRANSMISSION	9eP	9eP	UNDER THE SEAT LEFT	C/D50.E127

M - NUMBERS

- M 139 ADJUSTABLE SEAT HEATING, LEFT SEAT
- M 193 JAPAN VERSION
- M 249 AUTOMATIC TRANSMISSION
- M 340 ADJUSTABLE SEAT HEATING, RIGHT SEAT
- M 383 SPORT SEAT LEFT ELECTRIC HEIGHT ADJUSTMENT
- M 387 SPORT SEAT RIGHT ELECTRIC HEIGHT ADJUSTMENT
- M 425 REAR WINDOW WIPER
- M 437 COMFORT SEAT LEFT
- M 438 COMFORT SEAT RIGHT
- M 439 ELECTRIC CONVERTIBLE TOP
- M 454 CRUISE CONTROL
- M 513 LUMBAR SUPPORT SEAT RIGHT
- M 553 USA - CANADA VERSION
- M 562 AIRBAG
- M 573 AIR CONDITIONING SYSTEM
- M 576 WITHOUT REAR FOG LIGHT
- M 586 LUMBAR SUPPORT SEAT LEFT
- M 602 HIGH MOUNTED STOP LIGHT
- M 650 SUN ROOF
- M 659 ON-BOARD COMPUTER

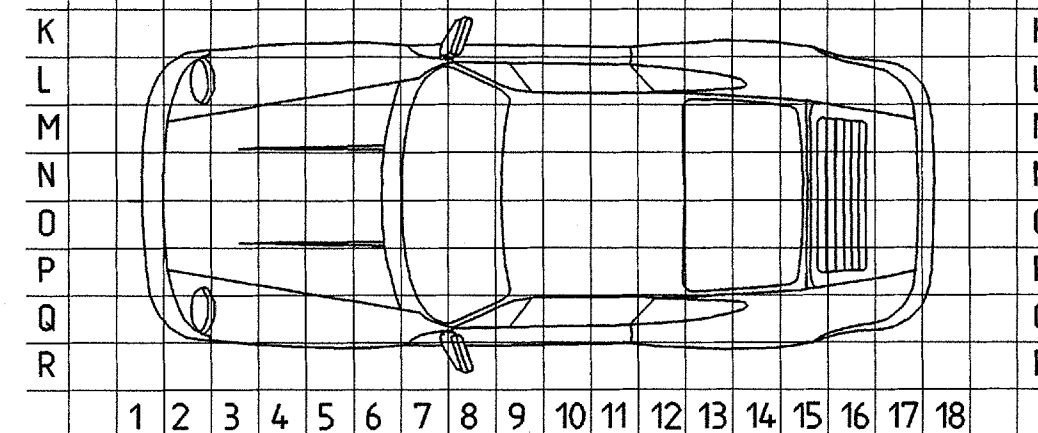
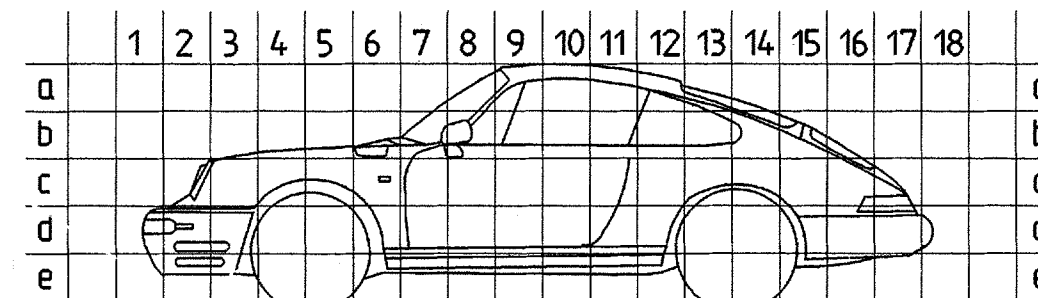

GROUND POINTS

CODE	NOTE	POSITION IN VEHICLE
		LEFT-HAND DRIVE
GP I	LUGGAGE COMPARTMENT, WHEEL HOUSING LEFT	2cP
GP II	LUGGAGE COMPARTMENT, WHEEL HOUSING RIGHT	2cM
GP III	ON FIREWALL	---
GP IV	GROUND FOR POWER CONSUMERS, UNDER SEAT LEFT	11eP
GP V	ELECTRONICS, UNDER SEAT LEFT	10eP
GP VI	CENTRAL ELECTRICS, ON SIDE MEMBER RIGHT	6bL
GP VII	ANTENNA AMPLIFIER ON SIDE MEMBER LEFT	7bL
GP VIII	INSIDE LIGHT CONVERTIBLE, ROOF CENTRE FRONT	9aN
GP IX	INSIDE LIGHT, ROOF RIGHT	11aL
GP IX	INSIDE LIGHT, ROOF LEFT	11aP
GP X	BATTERY, LUGGAGE COMPARTMENT LEFT	3eP
GP XI	GROUND STRAP (STARTER, TRANSMISSION, ENGINE, BODY)	14cM
GP XII	ENGINE COMPARTMENT REAR LEFT	15cQ
GP XIII	MOTOR LEFT	15cD
GP XIV	ENGINE COMPARTMENT REAR RIGHT	15cL
GP XV	INSTRUMENTS, SIDE MEMBER LEFT	7bQ
GP XVI	COMBINED LEAD REAR LEFT	13dP
GP XVII	COMBINED LEAD REAR RIGHT	12dM
GP XVIII	COMBINED LEAD FRONT RIGHT	4cM
GP XIX	COMBINED LEAD FRONT LEFT	4cP
GP XX	SEAT CROSS MEMBER, UNDER SEAT RIGHT	8eL
GP XXI	GROUND FOR POWER CONSUMERS, CONNECTION CRANK CASE	16cND
GP XXII	ELECTRONICS, CONNECTION CRANK CASE	16cND

ABBREVIATIONS

CODE	MEANING	CODE	MEANING
ABS	ANTILOCK BRAKING SYSTEM	PIN	PIN
AC	AIR CONDITIONING SYSTEM	POT	POTENTIOMETER
SS	SPEED SENSOR	PSD	PORSCHE LIMITED SLIP DIFFERENTIAL
DEF	DEFROST	RDK	TIRE PRESSURE CONTROL
ESO	ENGINE-SPEED SENSOR OUTPUT	ROW	REST OF WORLD
DME	DIGITAL ENGINE ELECTRONICS	RHD	RIGHT-HAND DRIVE
EZK	ELECTRIC IGNITION SYSTEM WITH KNOCK CONTROL	CL	CLOSE
FCU	FREQUENCY CONVERTER UNIT	SA	SAUDI ARABIA
RA	REAR AXLE	CU	CONTROL UNIT
HF	HIGH FREQUENCY	WP	WELD POINT
RL	REAR LEFT	HCS	HEADLIGHT CLEANING SYSTEM
RR	REAR RIGHT	PL	PLUG
IC	INSTRUMENT CLUSTER	DP	DISCONNECTING POINT
TE	TERMINAL	USA	USA
SCS	COMBINED STEERING COLUMN SWITCH	FA	FRONT AXLE
WL	WIRING LOOM	FL	FRONT LEFT
LED	LIGHT-EMITTING DIODE	FR	FRONT RIGHT
LHD	LEFT-HAND DRIVE	CP	CONNECTING POINT
GP	GROUND POINT	WW	WORLDWIDE
LF	LOW FREQUENCY	CES	CENTRAL ELECTRICS
FDG	FOG LIGHT	ADL	ADDITIONAL DRIVING LIGHTS
NO	NUMBER	CLS	CENTRAL LOCKING SYSTEM
RFL	REAR FOG LIGHT		
NTC	NEGATIVE TEMPERATURE COEFFICIENT		
OP	OPEN		

ADDITIONAL WIRING DIAGRAM TRAILER COUPLING

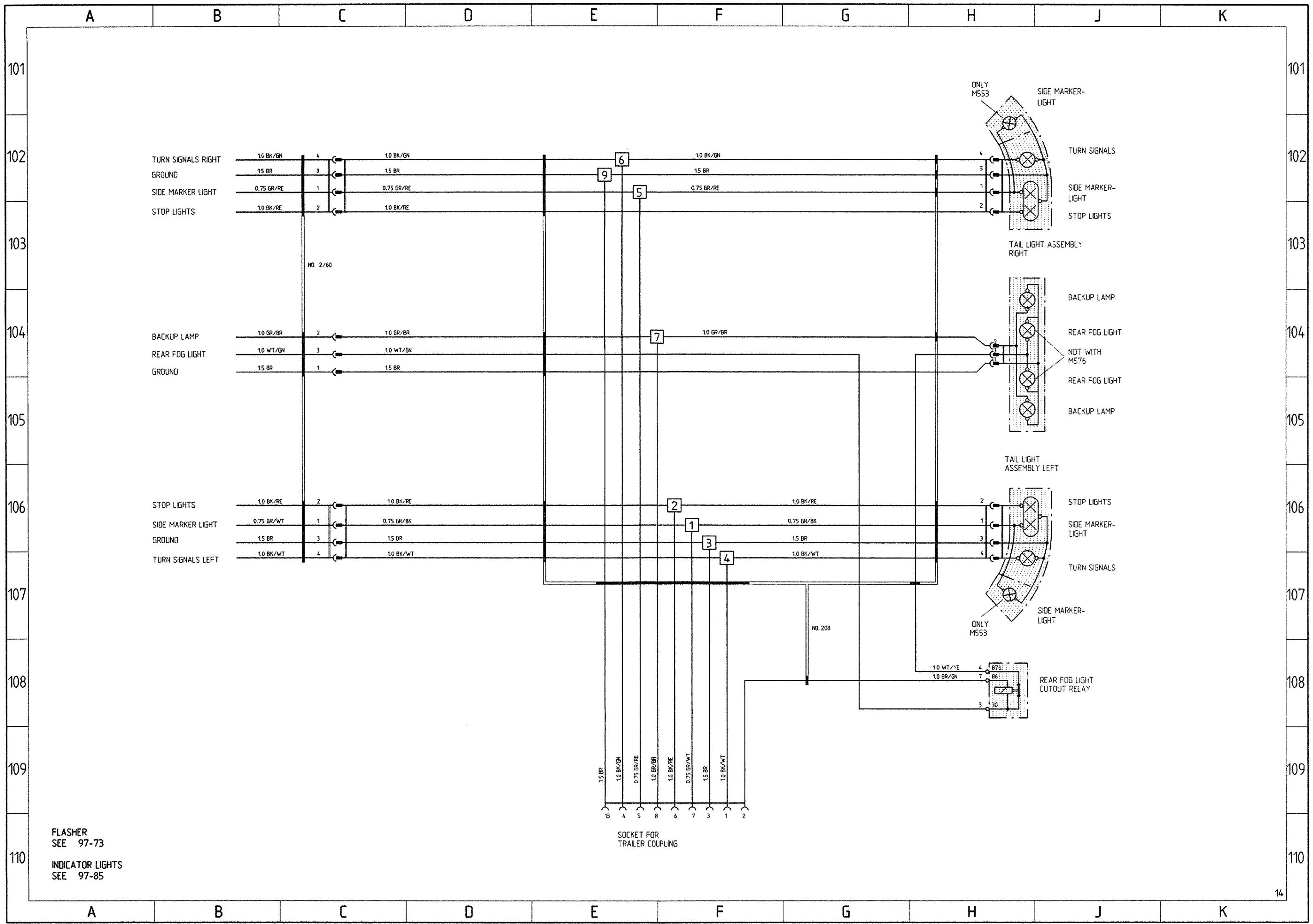

AIRBAG

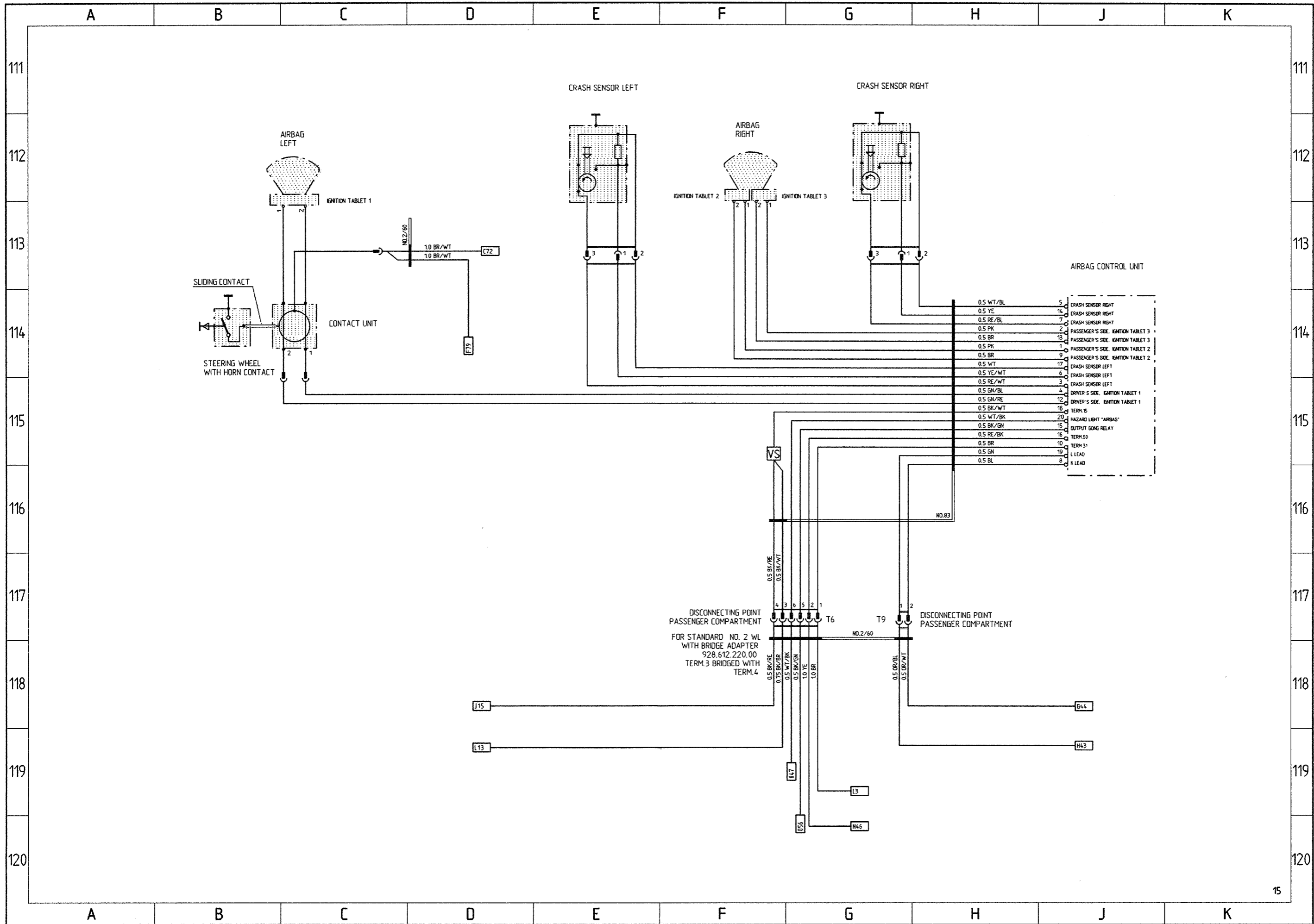

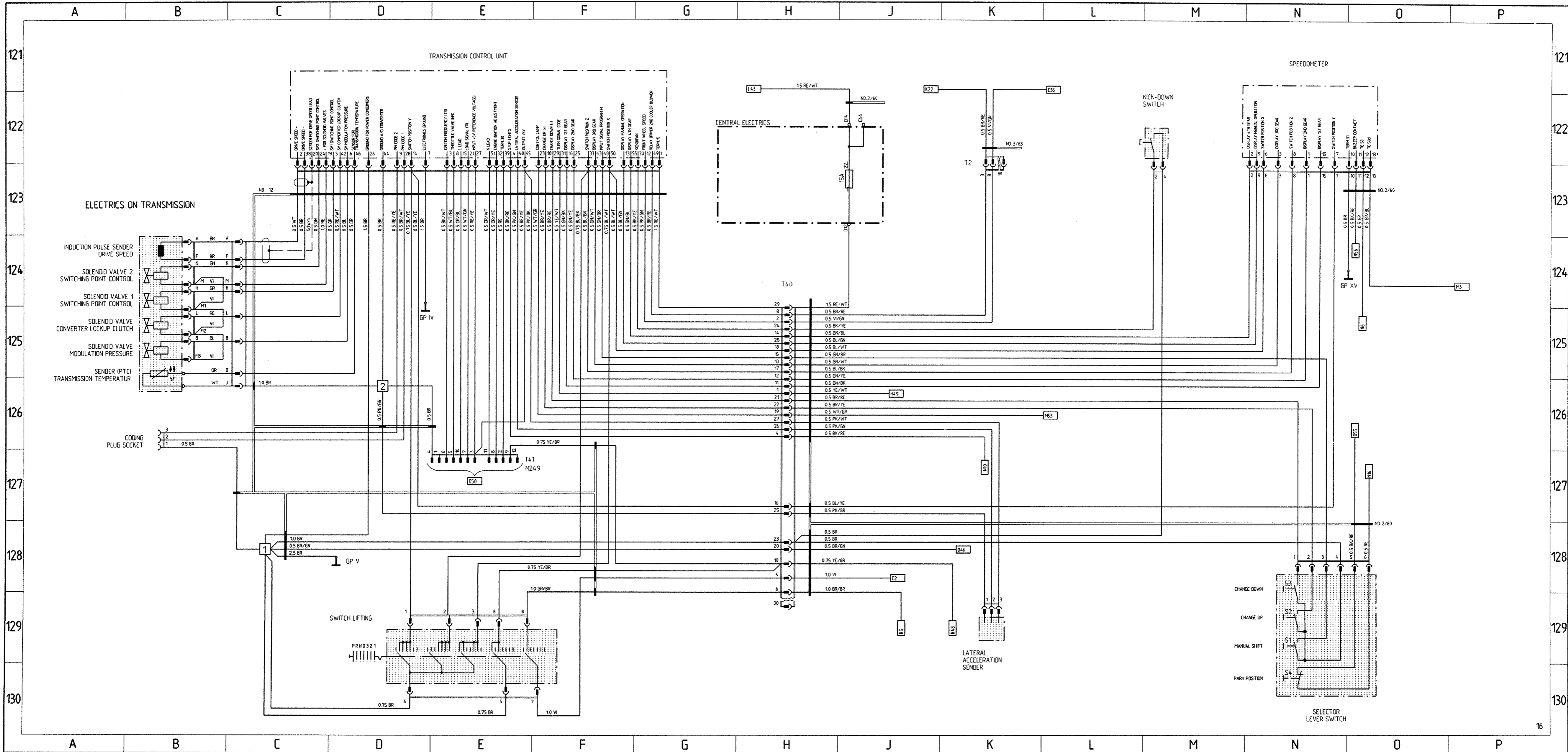

Changes to the circuit diagram for the 911 Carrera 2/4, models 89, 90**Sheet 5, D 50**

Within the update, ground points for the DME control unit were marked incorrectly.

2.5 mm² lead, brown, to ground point XXI.

1.5 mm² lead, brown, to ground point XXII.

Changes to the circuit diagram for the 911 Carrera 2/4 models 90, 91**Sheet 8, O/P 71/72 and L/M 79**

The zero travel, convertible top operation, top left-hand, top right-hand microswitches are drawn in the "open" position in the wiring diagrams. They are designed as normally closed switches, however; refer to model 92.

Please alter the circuit diagrams accordingly.

Wiring Diagram

Type 911 Carrera 2 and 4 Model 92

	Coordinates	
Sheet 1	1 - 10	Lights
Sheet 2	11 - 20	Alarm System, Central Locks, Mirror, Power Window Regulator, Inside Lights
Sheet 3	21 - 30	Heater, AC, Coolant Fan, Rear Window Defogger
Sheet 4	31 - 40	ABS, Porsche Dynamic AWD Control (Carrera 4)
Sheet 4a	31 - 40	ABS (Carrera 2)
Sheet 4b		ABS Turbo look (Carrera 2)
Sheet 5	41 - 50	Motor, Ignition, Cruise Control
Sheet 6	51 - 60	Instruments, Sender, Central Informer, On-board computer
Sheet 7	61 - 70	Seats
Sheet 8	71 - 80	Rear Spoiler, Two-Tone Horns, Wipe- and Wash Cleaners, Sun Roof, Convertible Top
Sheet 9	81 - 90	Radio, Telephone
Sheet 10	91 - 100	Fog Light, Rear Fog Light
Sheet 11		Central Electric
Sheet 12		Construction Components
Sheet 13		Plug Connections, Ground Points, M-Numbers, Abbreviations
Sheet 14	101 - 110	Trailer Coupling
Sheet 15	111 - 120	Airbag
Sheet 16	121 - 130	Tiptronic (Carrera 2)
Sheet 17	131 - 140	911 Carrera RS

Wiring Diagram

Type 911 Carrera 2 and 4 Model 92

The wiring diagram consists of *17 individual wiring diagrams*, 1 sheet *construction components* and 1 sheet *plug connections and ground points*. These are divided into coordinate fields.

Each individual wiring diagram contains a part of the central-electrics box in a dashdotted frame.

This part of the central-electrics box shows all the lines and relays necessary for the individual wiring diagram.

The earth/ground points are identified by "MP" and their location is shown in a vehicle diagram.

The 10-pin connectors on the central-electrics box are clipped together out of 3 parts, the 20-pin connectors are clipped together out of 5 parts.

Part 1, with the moduled-on fastening lug, is the "starting element".

Parts 2,3 and 4 are "module elements".

The 10-pin connectors only contents one "module element".

Start- and module elements are identified by the numbers 1.....5.

Part 5 ist a "coding element".

The designations of the plug connections in the wiring diagram refer to the "starting element" from, for example, B 11.....15, and to the first module element from B 21.....25.

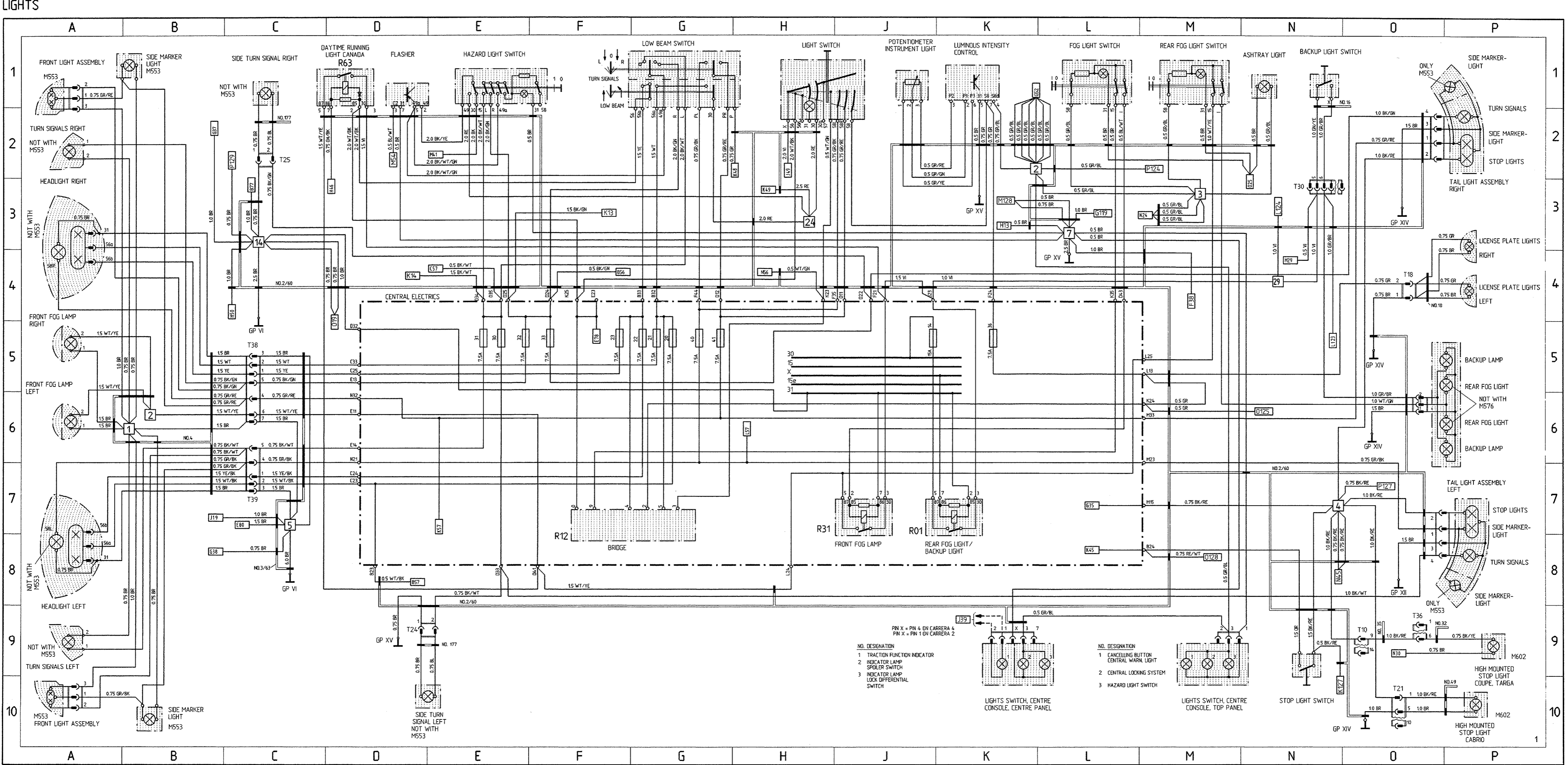

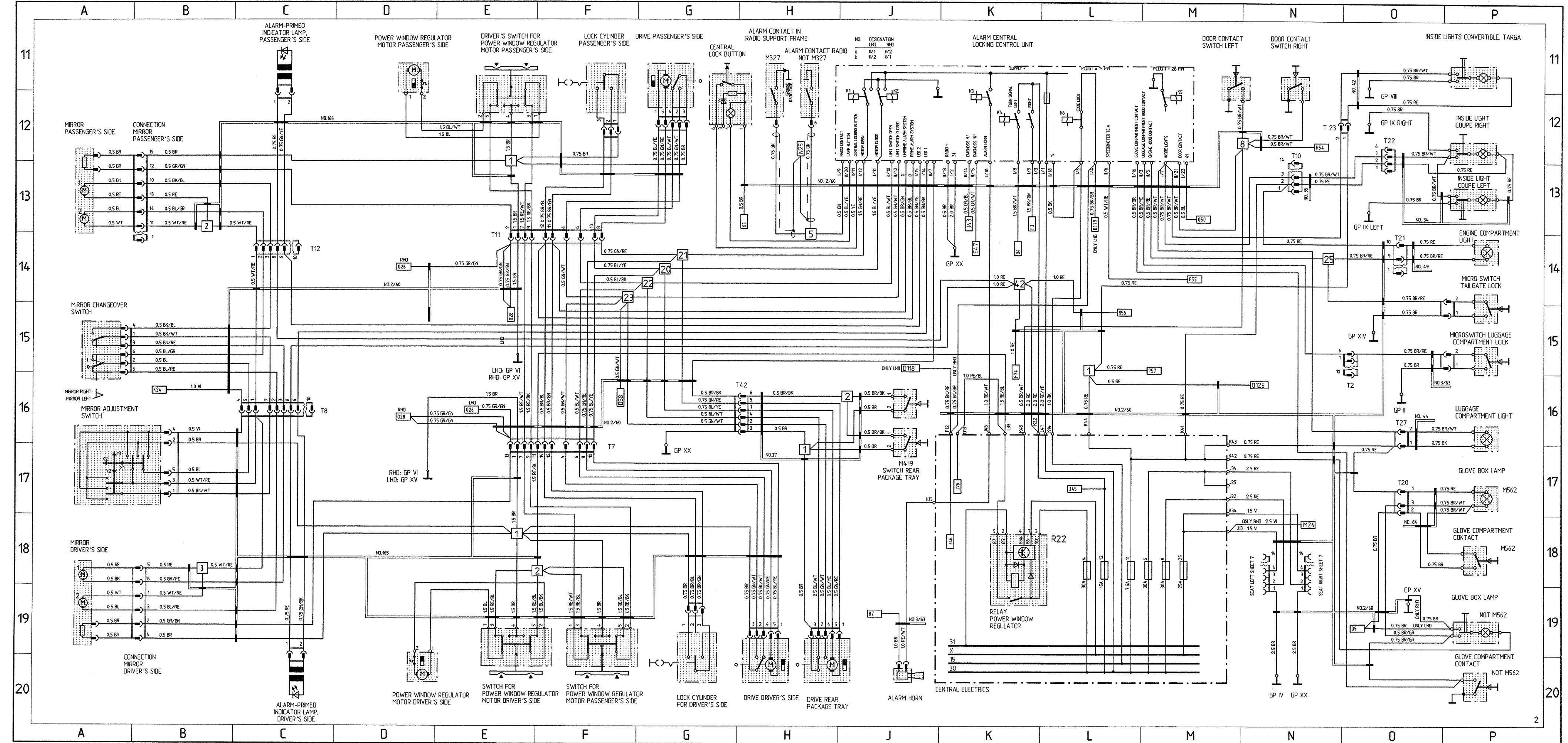

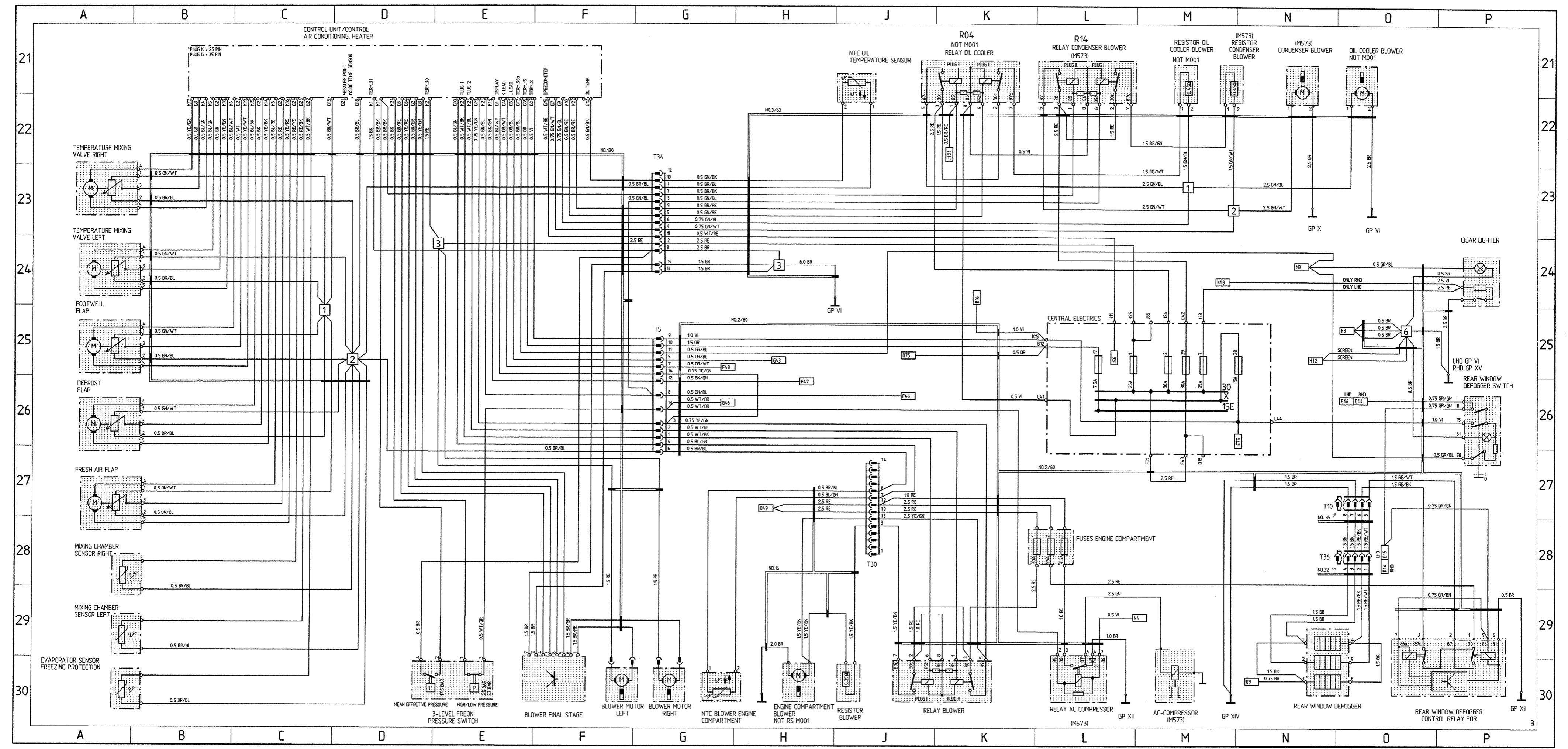

ABS, PORSCHE DYNAMIC AWD CONTROL

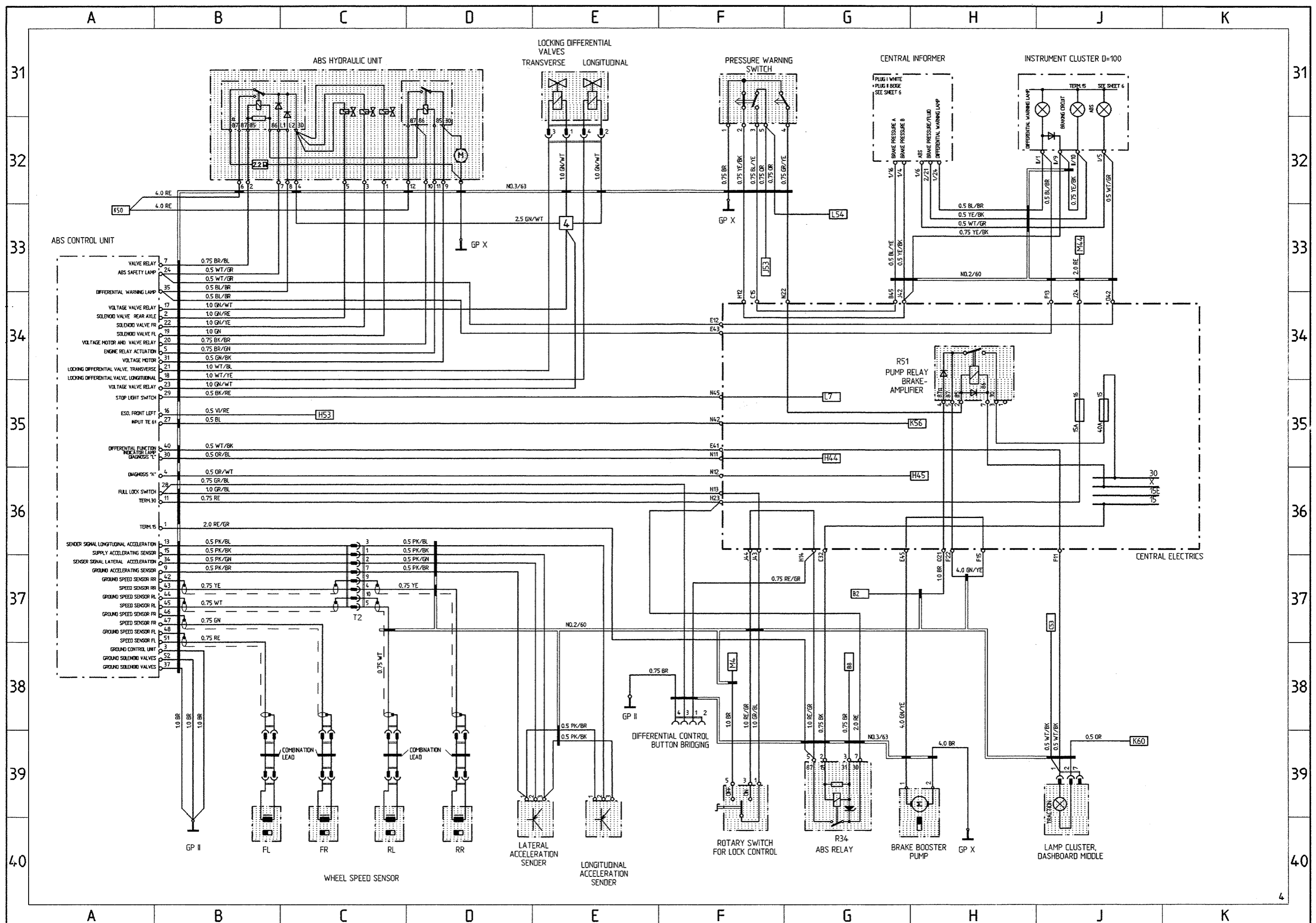

ABS

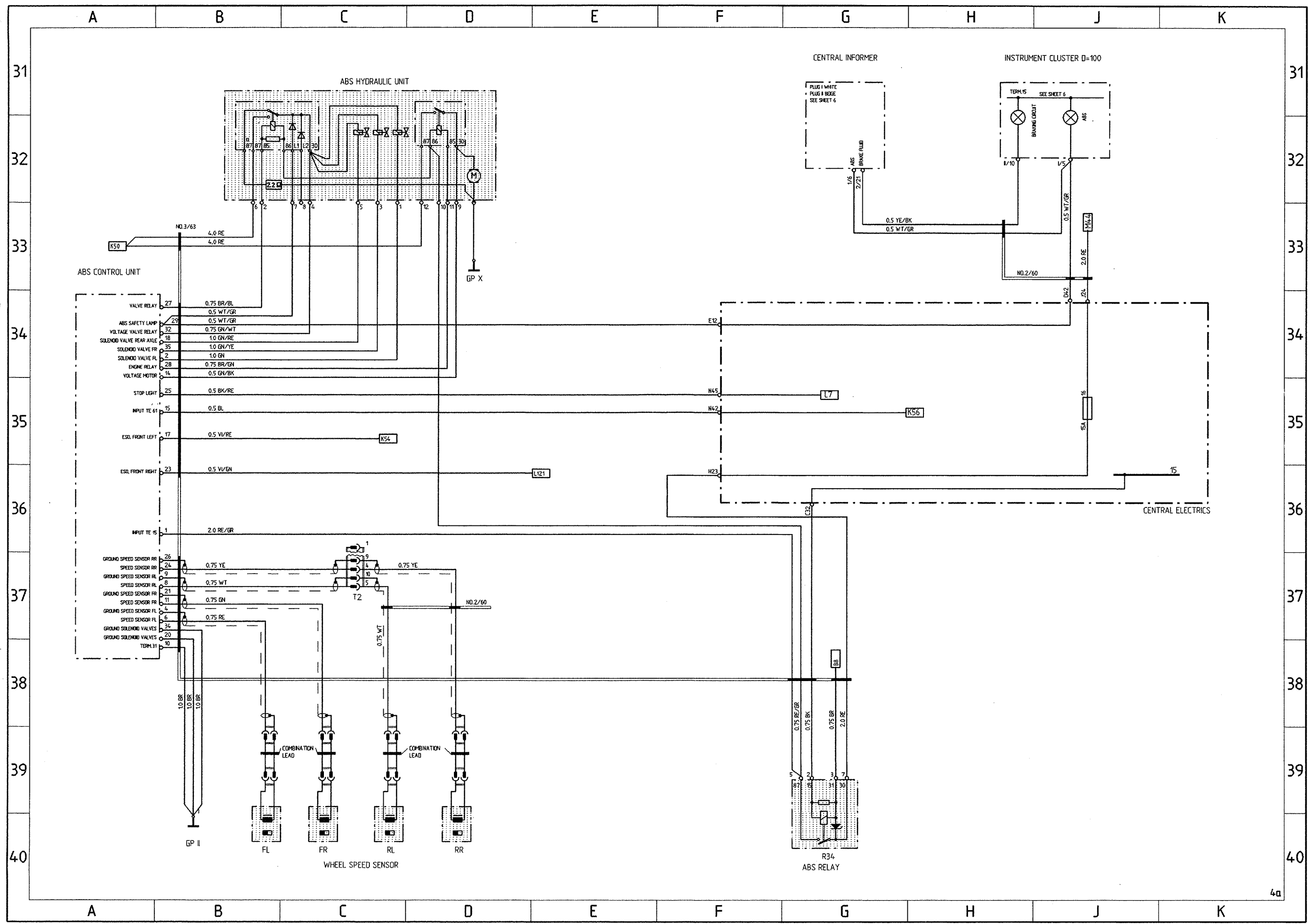

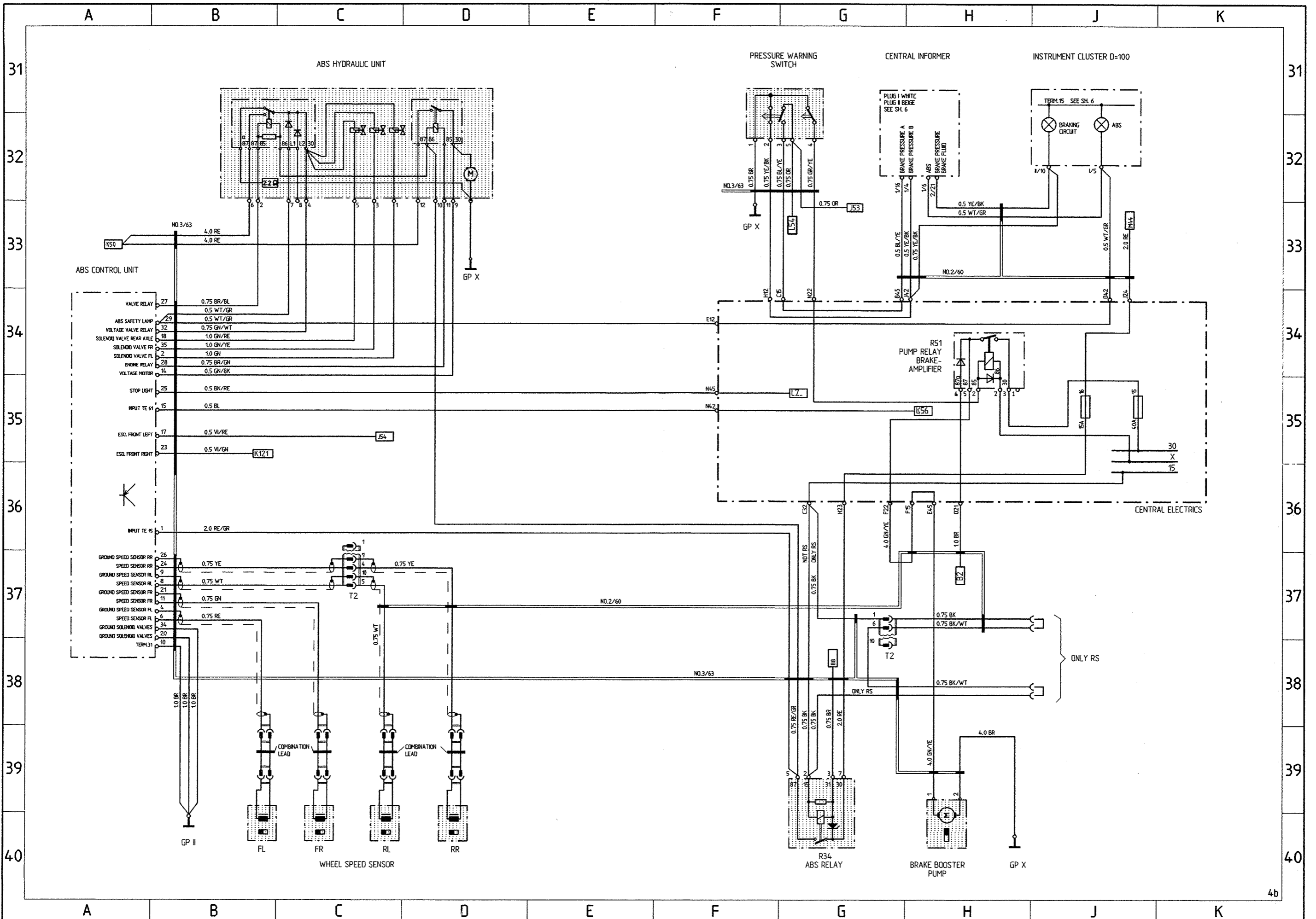

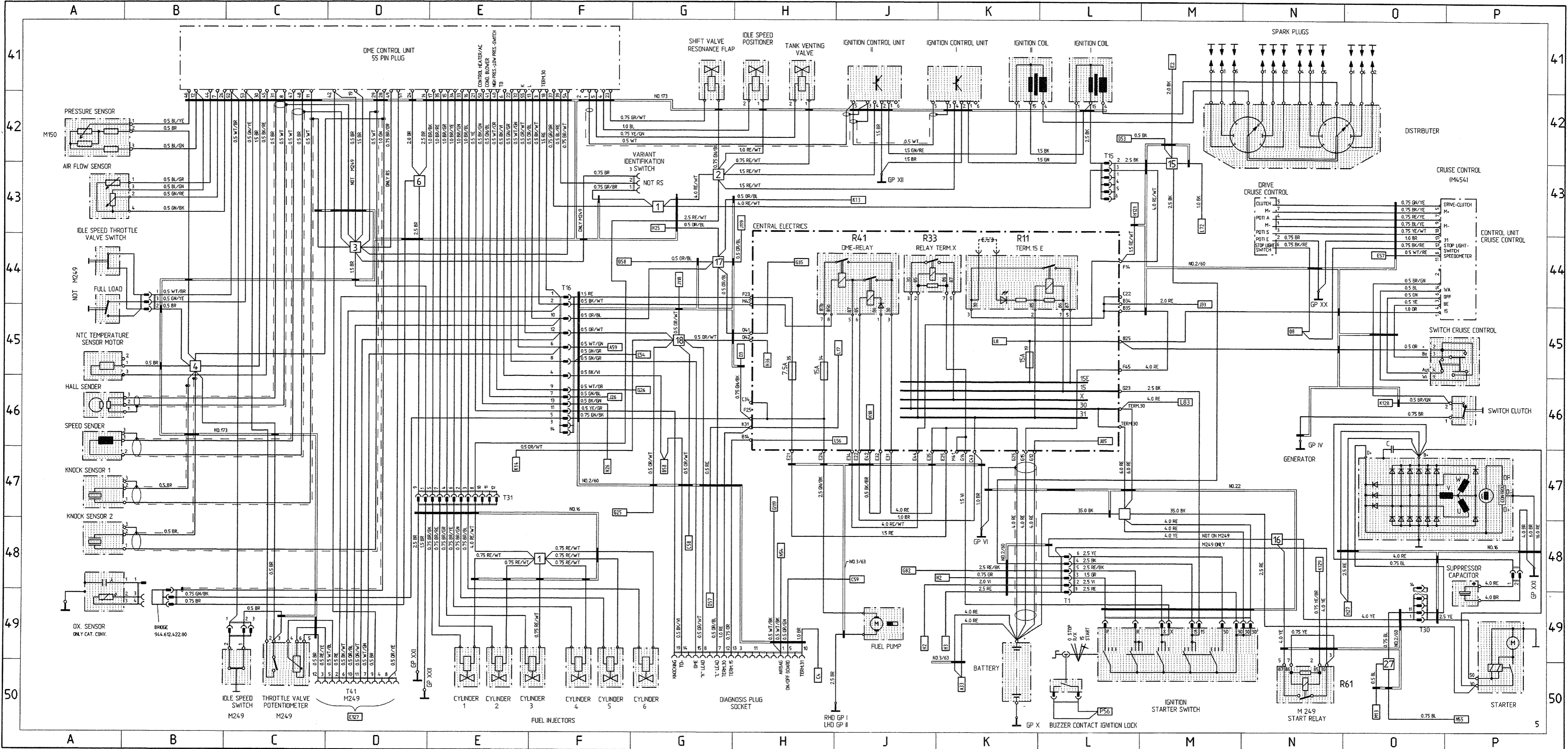

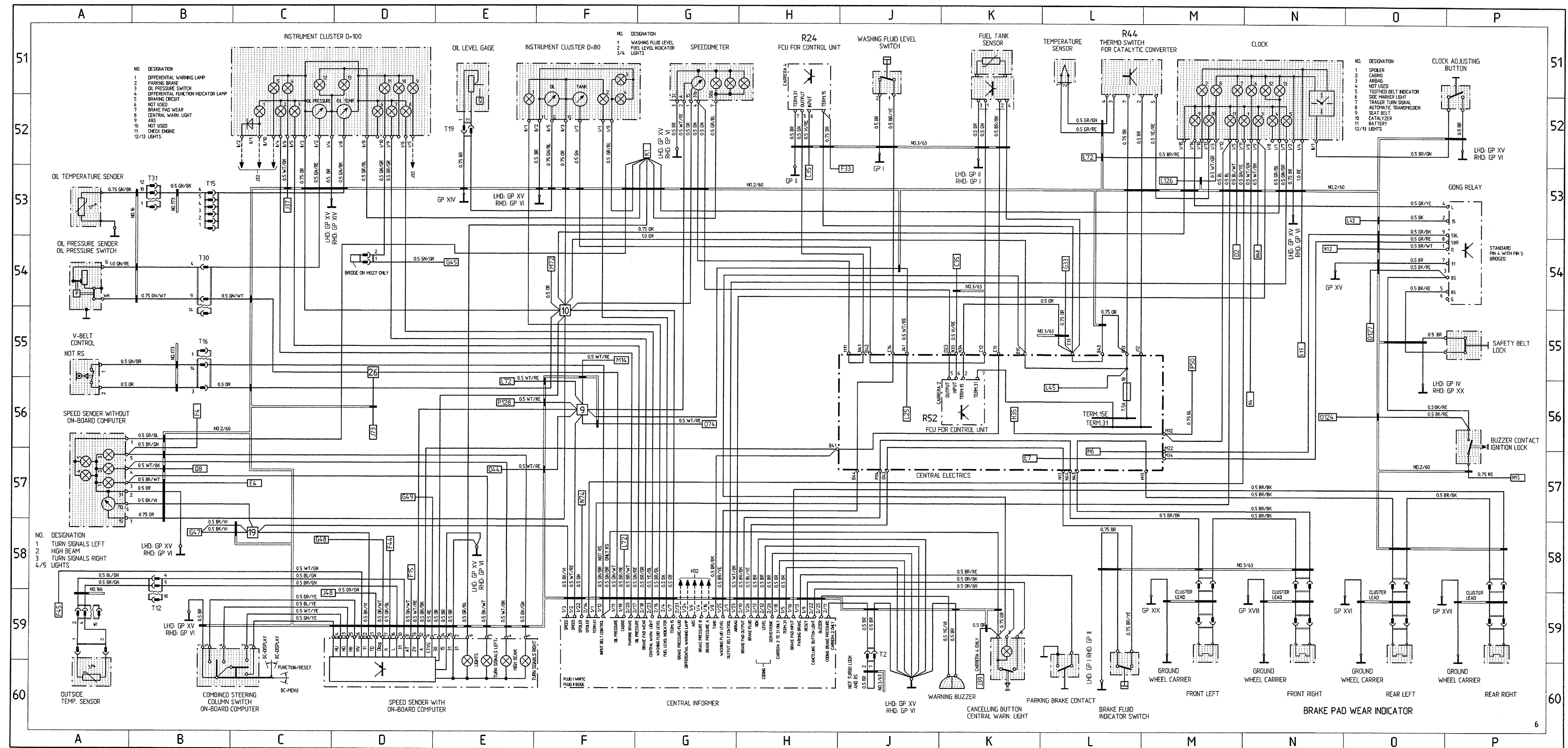

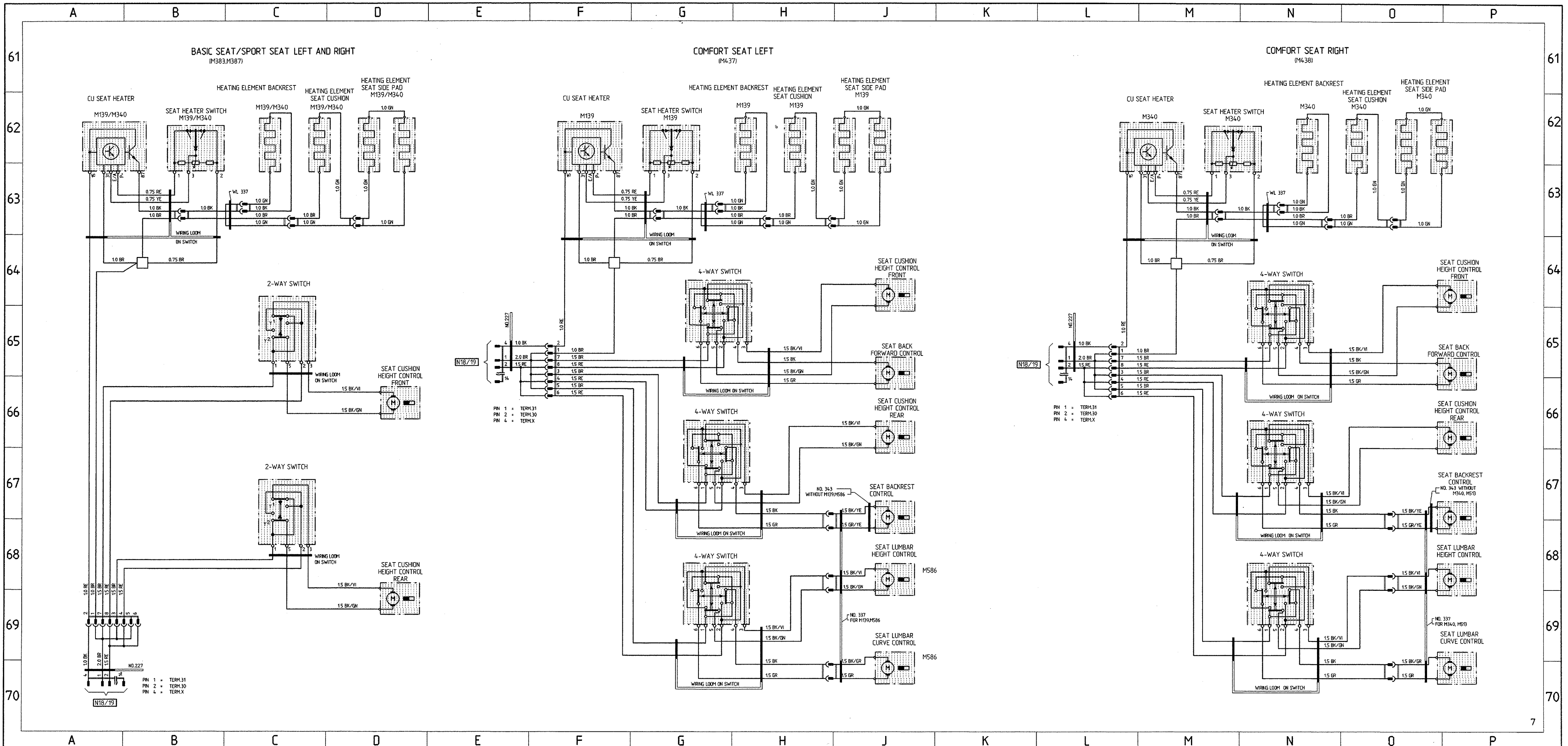

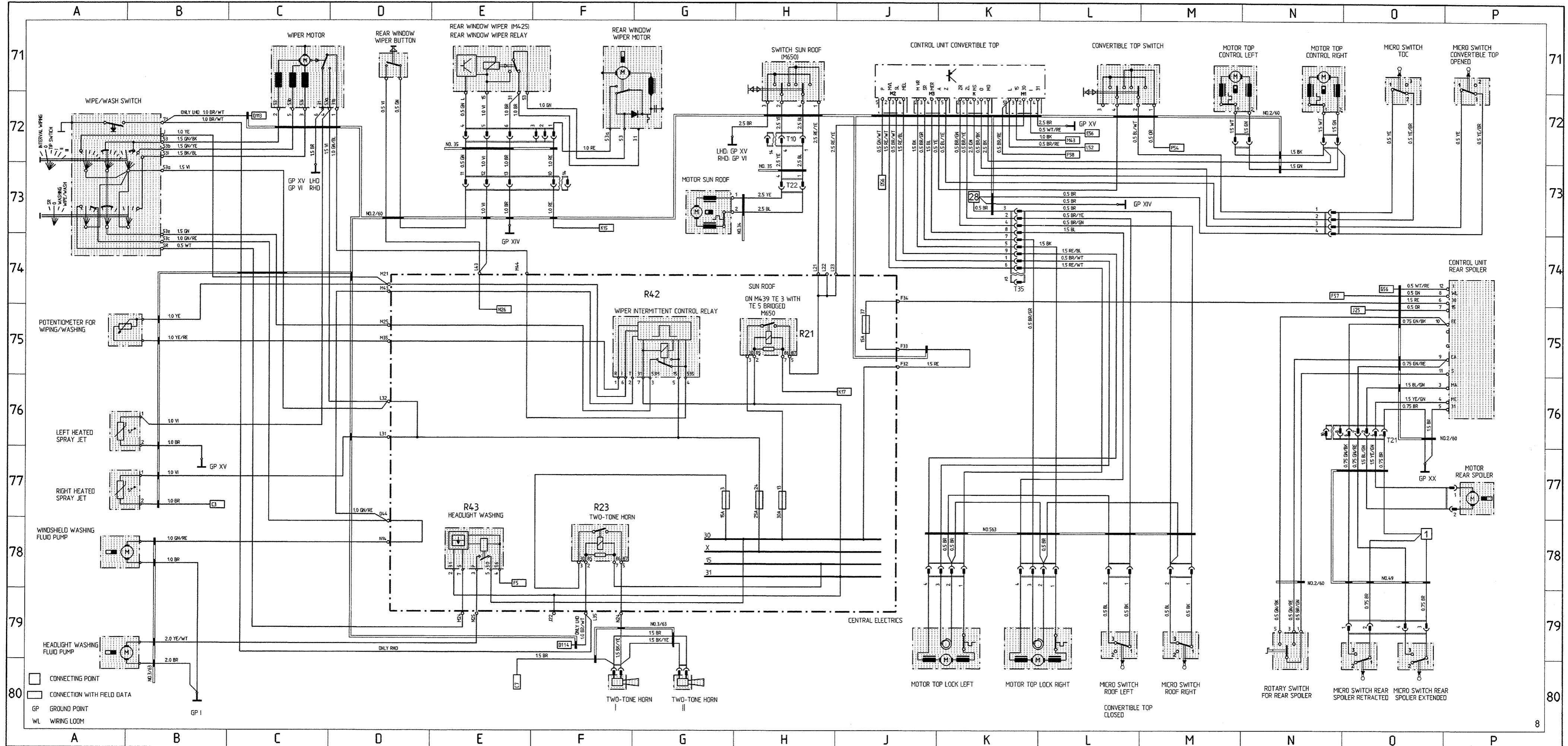

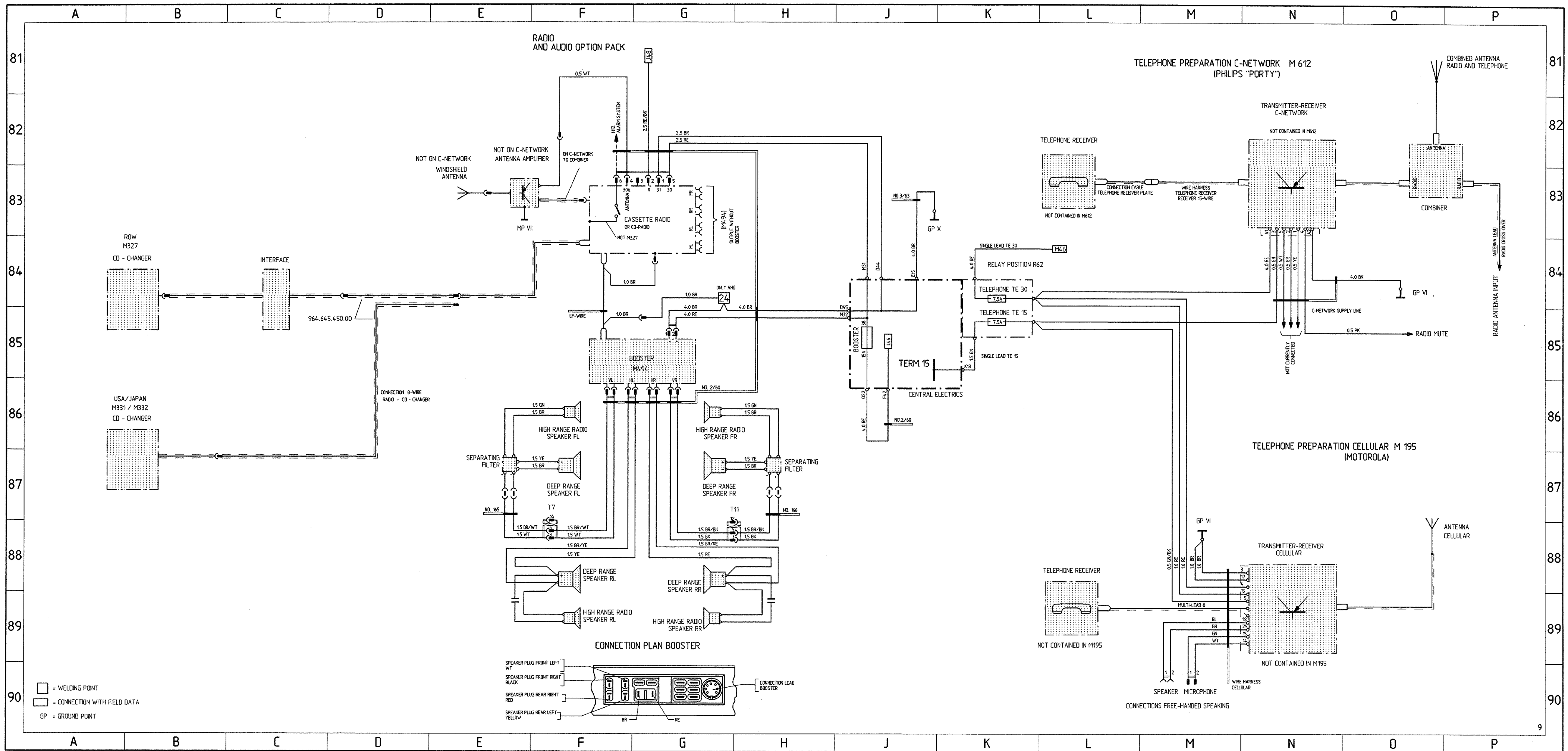

FOG LIGHT, REAR FOG LIGHT

FOG LIGHT- AND REAR FOG LIGHT-WIRINGS

ROW
FOG LIGHT +
REAR FOG LIGHT FROM 58

M4-87-NORWAY
FOG LIGHT + REAR FOG LIGHT
ONLY WITH 57

M553-USA
FOG LIGHT WITH 56b + 57

M193 JAPAN
FOG LIGHT +
REAR FOG LIGHT FROM 58

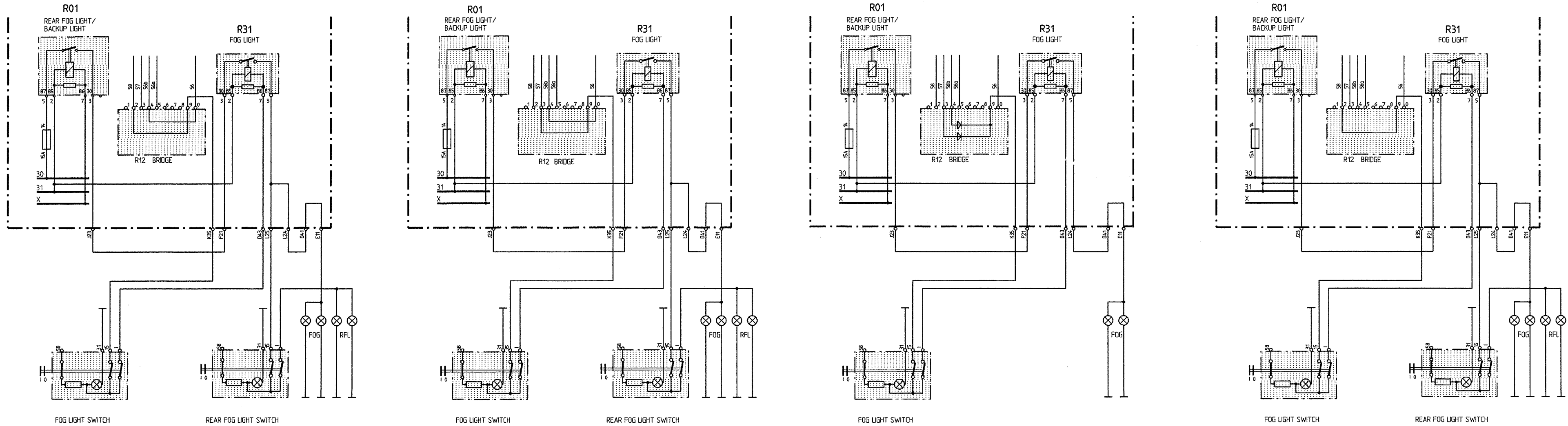

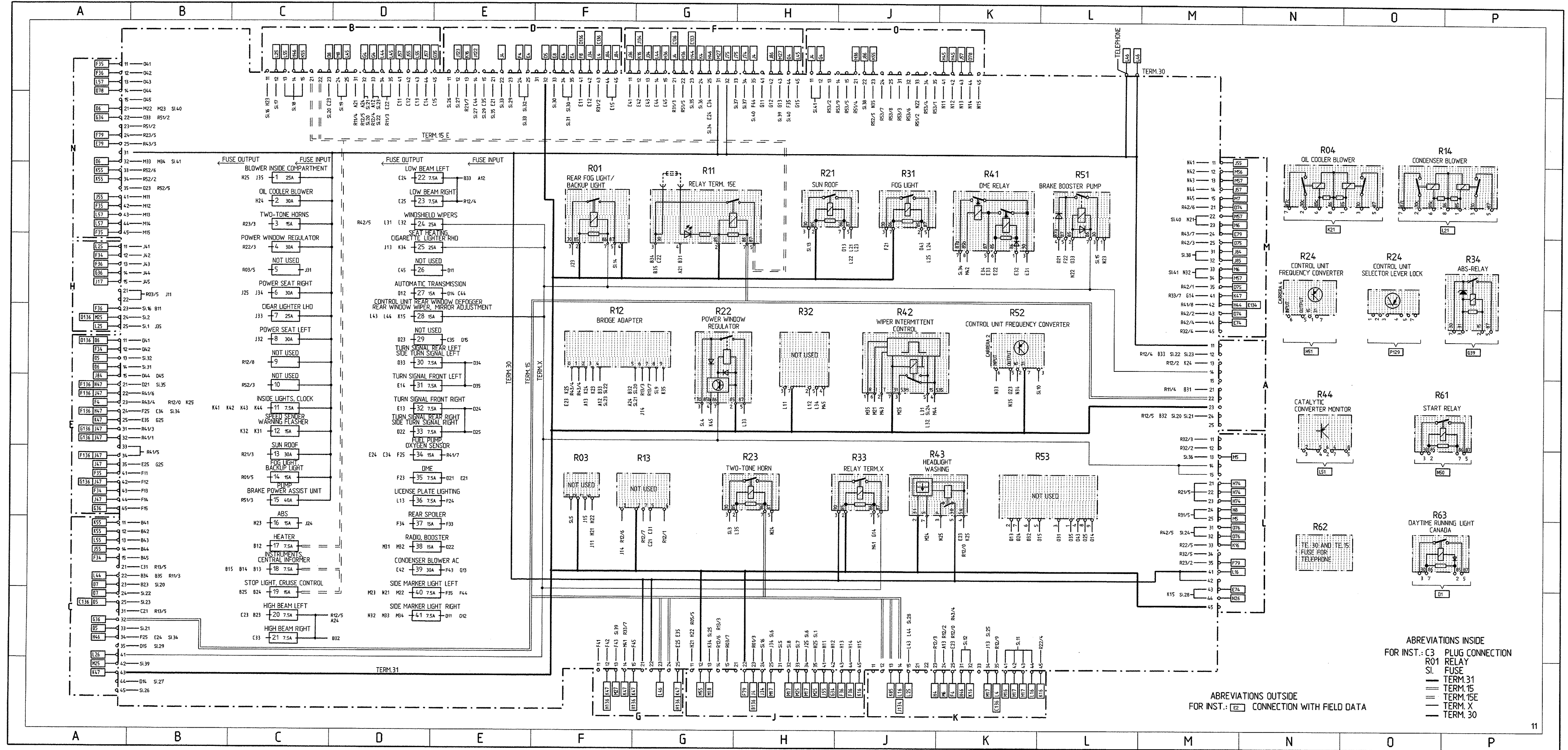

CONSTRUCTION COMPONENTS

DESIGNATION, FUNCTION	POSITION IN VEHICLE		NOTE	FIELD IN WIRING DIAGRAM
	LHD	RHD		
ABS RELAY	6cM	6cM	CENTRAL ELECTRICS	G39/40
ALARM HORN	3cL	3cL	IN WHEEL HOUSING FRONT RIGHT	J20
ANTENNA AMPLIFIER	7bL	7bQ	IN LUGGAGE COMPARTMENT	B84/E84
OUTSIDE TEMP. SENSOR	8bR	8bK	IN OUTSIDE MIRROR	B60
BATTERY MAIN SWITCH RS	2dN	2dN	IN LUGGAGE COMPARTMENT	H138/139
FLASHER	7dN	7dN	IN CENTRE CONSOLE	D1
BOOSTER	9eM	9eM	UNDER THE SEAT RIGHT	F/G85
STOP LIGHT SWITCH	6dP	6dM	AT THE BRAKE PEDAL BELOW THE FLOOR PANEL	N9
DIAGNOSIS CONNECTION	7cL	7cQ	IN PASSENGER'S FOOTWELL	G/H50
DME RELAY	6cM	6cM	CENTRAL ELECTRICS	J44
DME CONTROL UNIT	9eP	9eP	UNDER THE SEAT LEFT	B-F41
SPEED SENDER	15cP	15cP	BY ENGINE LEFT	A47
THROTTLE VALVE POTENTIOMETER, AUTOM. TRANSMISSION	15bN	15bN	ON THROTTLE VALVE ASSEMBLY	C50
THROTTLE VALVE SWITCH, MANUAL TRANSMISSION	15bN	15bN	ON THROTTLE VALVE ASSEMBLY	A44/45
PRESSURE SENSOR	10eP	10eP	UNDER THE SEAT LEFT	A42
PRESSURE WARNING SWITCH	1dO	1dO	IN LUGGAGE COMPARTMENT	F31
PRESSURE SWITCH AIR CONDITIONING SYSTEM	6bO	---	IN LUGGAGE COMPARTMENT	E30
TWO-TONE HORN I	3cL	3cL	IN WHEEL HOUSING FRONT RIGHT	F80
TWO-TONE HORN II	3cL	3cL	IN WHEEL HOUSING FRONT RIGHT	G80
SEPARATING FILTER FL	9dQ	9dQ	UNDER THE DOOR TRIM PANEL	E87
SEPARATING FILTER FR	9dL	9dL	UNDER THE DOOR TRIM PANEL	H87
CRASH SENSOR RIGHT	4cM	---	IN LUGGAGE COMPARTMENT	G112/113
CRASH SENSOR LEFT	4cP	---	IN LUGGAGE COMPARTMENT	F112/113
BLOWER FINAL STAGE	6bN	6bN	IN LUGGAGE COMPARTMENT	F30
BLOWER ENGINE COMPARTMENT	16cO	16cO	ON ENGINE	H30
BLOWER MOTOR RIGHT	6cM	6cM	IN LUGGAGE COMPARTMENT	G30
BLOWER MOTOR LEFT	6cP	6cP	IN LUGGAGE COMPARTMENT	F30
GONG RELAY	6cP	---	BY STEERING COLUMN LEFT	P53/54
HALL SENDER	17cO	17cO	ON DISTRIBUTOR	A46
REAR WINDOW WIPER RELAY	15bO	15bO	ON REAR WINDOW WIPER MOTOR	E71
HYDRAULIC UNIT ABS	3dP	3dP	IN LUGGAGE COMPARTMENT	C32
V-BELT CONTROL	17dO	17dO	ON ENGINE	A55/56
MAP ALTERATION-SWITCH	9eP	9eP	UNDER THE SEAT LEFT	G42
KICK-DOWN SWITCH	6dO	6dM	BY ACCELERATOR PEDAL UNDER FLOOR PANEL	M122
KNOCK SENSOR 1	15cP	15cP	BY ENGINE LEFT	A47
KNOCK SENSOR 2	16cN	16cN	BY ENGINE TOP	A48
CONDENSER BLOWER	2dQ	2dQ	IN WHEEL HOUSING FRONT LEFT	N21
FUEL PUMP	6eM	6eP	BEHIND THE BASE	J49
CLUTCH SWITCH CRUISE CONTROL	6dP	6dN	BY CLUTCH PEDAL UNDER FLOOR PANEL	P46
LONGITUDINAL ACCELERATION SENDER	7dN	7dN	IN CENTRE CONSOLE	E40
LOCKING DIFFERENTIAL VALVES LONGIT. AND TRANSVERSE	3dM	3dM	IN LUGGAGE COMPARTMENT	E31
IDLE SPEED SWITCH AUTOMATIC TRANSMISSION	15bN	15bN	ON ENGINE	C50
IDLE SPEED POSITIONER	15bN	15bN	ENGINE COMPARTMENT	H41
AIR FLOW SENSOR	16bO	16bO	ON ENGINE	A43
MICRO SWITCH ROOF RIGHT	9aN	9aN	AT CONVERTIBLE TOP FRAME	M79
MICRO SWITCH ROOF LEFT	9aO	9aO	AT CONVERTIBLE TOP FRAME	L79
MICRO SWITCH REAR SPOILER EXTENDED	16bP	16bP	ON TAILGATE	O79
MICRO SWITCH REAR SPOILER RETRACTED	16bP	16bP	ON TAILGATE	O79
MICRO SWITCH TDC	12cL	12cL	BEHIND SIDE PANEL COVERING	O71
MICROSWITCH FOR TOP CONTROL	12cL	12cL	BEHIND SIDE PANEL COVERING	P71
MOTOR SUN ROOF	12aN	12aN	IN ROOF	G73
MOTOR TOP CONTROL RIGHT	15cN	15cN	BEHIND REAR SEAT	N71
MOTOR TOP CONTROL LEFT	15cO	15cO	BEHIND REAR SEAT	M71
MOTOR TOP LOCK RIGHT	9aN	9aN	AT CONVERTIBLE TOP FRAME	K/L79
MOTOR TOP LOCK LEFT	9aO	9aO	AT CONVERTIBLE TOP FRAME	J/K79
REAR FOG LIGHT CUTOFF RELAY	17dN	17dN	BEHIND REAR PANEL	A108
NTC HEATER FAN	16cP	16cP	ENGINE COMPARTMENT	G30
OIL PRESSURE SENDER/SWITCH	14cN	14cN	ON ENGINE	A54
OIL COOLER BLOWER	2dL	2dL	IN WHEEL HOUSING FRONT RIGHT	O21
OIL LEVEL GAGE	12cK	12cK	IN WHEEL HOUSING REAR RIGHT	E51/52

DESIGNATION, FUNCTION	POSITION IN VEHICLE		NOTE	FIELD IN WIRING DIAGRAM
	LHD	RHD		
OIL TEMPERATURE SENDER FOR INSTRUMENT	14cN	14cN	ON ENGINE	A53
OIL TEMPERATURE SENDER SENDER FOR OIL COOLER BLOWER	2dL	2dL	IN WHEEL HOUSING FRONT RIGHT	J21
SWITCH LIFTING	12cO	12cO	ON GEARBOX	D-F129
BRAKE BOOSTER PUMP	1dO	1dO	IN LUGGAGE COMPARTMENT	H39/40
LATERAL ACCELERATION SENDER ABS	7dN	7dN	IN CENTRE CONSOLE	D40
LATERAL ACCELERATION SENDER AUTOMATIC TRANSMISSION	7dN	7dN	IN CENTRE CONSOLE	K129
CONTROL RELAY REAR WINDOW DEFOGGER	16cP	16cP	CARRIER PLATE IN ENGINE COMPARTMENT	O/P29/30
RELAY CONDENSER BLOWER	N9	6cM	CENTRAL ELECTRICS	L21
RELAY AC COMPRESSOR	16cP	16cP	CARRIER PLATE IN ENGINE COMPARTMENT	L30
RELAY TWO-TONE HORN	6cM	6cM	CENTRAL ELECTRICS	F78
RELAY POWER WINDOW REGULATOR	6cM	6cM	CENTRAL ELECTRICS	K18/19
RELAY FREQUENCY TRANSFORMER	6cM	6cM	CENTRAL ELECTRICS	K56/H51
RELAY BLOWER ENGINE COMPARTMENT	16cP	16cP	CARRIER PLATE IN ENGINE COMPARTMENT	J/K30
RELAY STARTER AUTOMATIC TRANSMISSION	6cM	6cM	CENTRAL ELECTRICS	N50
RELAY BACKUP LIGHT	7bQ	7bQ	IN LUGGAGE COMPARTMENT LEFT	L122
RELAY THERMO SWITCH CATALYTIC CONVERTER	6cM	6cM	CENTRAL ELECTRICS	L/M51
RELAY TERM.X	6cM	6cM	CENTRAL ELECTRICS	K44
RELAY TERM.15 E	6cM	6cM	CENTRAL ELECTRICS	K/L44
RELAY REAR FOG LIGHT-BACKUP LIGHT	6cM	6cM	CENTRAL ELECTRICS	J/K7
RELAY FRONT FOG LAMP	6cM	6cM	CENTRAL ELECTRICS	J7
RELAY OIL COOLER BLOWER	6cM	6cM	CENTRAL ELECTRICS	K21
RELAY BRAKE BOOSTER PUMP	6cM	6cM	CENTRAL ELECTRICS	H34/35
RELAY SUN ROOF	6cM	6cM	CENTRAL ELECTRICS	H75
RELAY DAYTIME RUNNING LIGHT CANADA	6cM	6cM	CENTRAL ELECTRICS	D1
BACKUP LIGHT SWITCH	14dN	14dN	BY TRANSMISSION RIGHT	N1
SHIFT VALVE RESONANCE FLAP	15bN	15bN	ON ENGINE	G41
WINDSHIELD WASHING FLUID PUMP	3cQ	3cQ	BY WASHING FLUID RESERVOIR IN WHEEL HOUSING FL	A78
WINDSHIELD WASHING FLUID PUMP RS	4cQ	4cQ	IN LUGGAGE COMPARTMENT	A78
FUSES ENGINE COMPARTMENT	16cP	16cP	CARRIER PLATE IN ENGINE COMPARTMENT	L28
HEADLIGHT CLEANER PUMP	3cQ	3cQ	BY WASHING FLUID RESERVOIR IN WHEEL HOUSING FL	A79/80
HEADLIGHT CLEANER RELAY	6cM	6cM	CENTRAL ELECTRICS	E78
STARTER	14dN	14dN	BY CLUTCH HOUSING RIGHT	P49/50
DRIVE CRUISE CONTROL	15cO	15cO	ON ENGINE	N43/44
CONTROL UNIT ABS	2dM	2dM	IN LUGGAGE COMPARTMENT	A33-38
CONTROL UNIT AIRBAG	6cO	---	ON INSTRUMENT PANEL	J114/115
CONTROL UNIT ALARM SYSTEM/CENTRAL LOCKING SYSTEM	9eM	9eM	UNDER THE SEAT RIGHT	J-M12
CONTROL UNIT AUTOMATIC TRANSMISSION	10dP	10dP	UNDER THE SEAT LEFT	C-6122
CONTROL UNIT CONVERTIBLE TOP	6cP	6cP	ON INSTRUMENT PANEL	J/K71
CONTROL UNIT INSTRUMENT LIGHT	7bQ	7bQ	IN LUGGAGE COMPARTMENT LEFT	K1
CONTROL UNIT REAR SPOILER	6cM	6cP	INSIDE FIREWALL RIGHT/LEFT	P74-76
CONTROL UNIT HEATING, AIR CONDITIONING	7cQ	7cN	ON INSTRUMENT PANEL	B-F21
CONTROL UNIT SELECTOR LEVER LOCK	6cM	6cM	CENTRAL ELECTRICS	O/P129/130
CONTROL UNIT CRUISE CONTROL	9eN	9eN	UNDER THE SEAT RIGHT	P43/44
BUZZER CONTACT	7cP	7cM	ON IGNITION LOCK	P56
FUEL LEVEL SENDER	5cM	5cP	IN FUEL TANK	K51
TANK VENTING VALVE	15cN	15cN	BY ENGINE TOP	H41
TEMPERATURE MOTOR	15cP	15cP	BY ENGINE LEFT	A45
VARIANT IDENTIFICATION SWITCH	9eP	9eP	UNDER THE SEAT LEFT	G43
RESISTOR BLOWER	16dP	16dP	ENGINE COMPARTMENT	J30
RESISTOR FOR BLOWER CONDENSER	2dQ	2dQ	IN WHEEL HOUSING FRONT LEFT	M21
RESISTOR OIL COOLER BLOWER	2dL	2dL	IN WHEEL HOUSING FRONT RIGHT	M21
WARNING BUZZER	7cP	7cP	ON INSTRUMENT PANEL	K60
WIPER INTERMITTENT CONTROL RELAY	6cM	6cM	CENTRAL ELECTRICS	F/G75
CENTRAL ELECTRICS	6cM	6cM	IN LUGGAGE COMPARTMENT	---
CENTRAL INFORMER	6cP	6cP	ON STEERING COLUMN	H32/F/G/H59
IGNITION CONTROL UNIT I	15cP	15cP	IN ENGINE COMPARTMENT LEFT	K41
IGNITION CONTROL UNIT II	15cP	15cP	IN ENGINE COMPARTMENT LEFT	J41
IGNITION COIL I	15cO	15cO	IN ENGINE COMPARTMENT LEFT	L41
IGNITION COIL II	15cO	15cO	IN ENGINE COMPARTMENT LEFT	K41

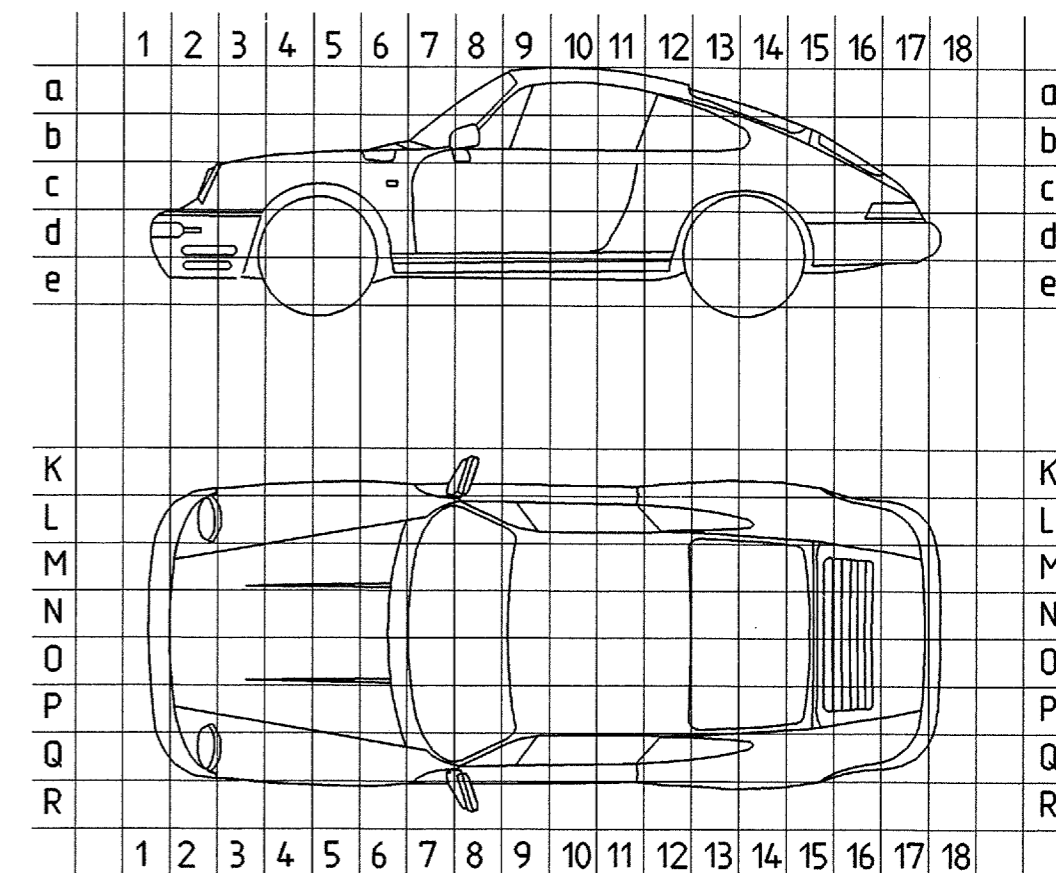

A B C D E F G H J K L M N O P

PLUG CONNECTIONS

CODE	NUMBER OF PINS	DESIGNATION, FUNCTION	POSITION IN VEHICLE		NOTE	FIELD
			LHD	RHD		
T1	6	IGNITION LOCK	6cP	6cM	BY STEERING COLUMN LEFT	L48
T2	10	ABS	6cL	6cL	IN LUGGAGE COMPARTMENT RIGHT	C36/37, K12, 0152
T5	14	HEATER, AIR CONDITIONER	6cM	6cM	UNDER INSTRUMENT PANEL RIGHT	G25/26
T6	6	AIRBAG	7dN	7dN	IN CENTRE CONSOLE	F/G117
T7	14	DOOR DRIVER'S SIDE	6cD	6cL	UNDER INSTRUMENT PANEL LEFT	A88.F88.E/F17
T8	10	DOOR DRIVER'S SIDE	6cQ	6cL	UNDER INSTRUMENT PANEL LEFT	C16
T9	2	AIRBAG	7dN	7dN	IN CENTRE CONSOLE	G117
T10	14	REAR WINDOW SHELF	12cL	12cL	BEHIND SIDE PANEL COVERING	D9N13.027.E/F73.H72
T11	12	DOOR PASSENGER'S SIDE	6cL	6cQ	UNDER INSTRUMENT PANEL RIGHT	E14.D88.H88
T12	10	DOOR PASSENGER'S SIDE	6cL	6cQ	UNDER INSTRUMENT PANEL RIGHT	B59.C14
T15	6	DME	9eP	9eP	UNDER THE SEAT LEFT	L43.C14.B53
T16	14	DME	9eP	9eP	UNDER THE SEAT LEFT	F45/46.B55
T18	2	LICENSE PLATE LIGHTS	17dL	17dL	TAIL LIGHTS RIGHT	04
T19	2	OIL LEVEL GAGE	15cM	15cM	IN ENGINE COMPARTMENT RIGHT	E52
T20	3	GLOVE BOX LAMP AIRBAG	6cL	—	UNDER INSTRUMENT PANEL RIGHT	D17
T21	10	TAILGATE	15cL	15cL	IN ENGINE COMPARTMENT RIGHT	N76.013.010
T22	4	INSIDE LIGHTS, SUN ROOF	15bM	15bM	BELOW THE PARCEL TRAY	H73.012
T23	2	INSIDE LIGHTS CONVERTIBLE, TARGA	6cQ	6cQ	UNDER INSTRUMENT PANEL LEFT	D12
T24	2	SIDE TURN SIGNAL LEFT	7bQ	7bQ	IN LUGGAGE COMPARTMENT ON SIDE MEMBER LEFT	D/E9
T25	2	SIDE TURN SIGNAL RIGHT	7bL	7bL	IN LUGGAGE COMPARTMENT ON SIDE MEMBER RIGHT	C2
T27	2	LUGGAGE COMPARTMENT LIGHT	7bL	7bL	IN LUGGAGE COMPARTMENT ON SIDE MEMBER RIGHT	D16
T30	14	NO. 16 MOTOR	16cP	16cP	CARRIER PLATE IN ENGINE COMPARTMENT	N/03.J27/28.048/49.B54
T31	12	MOTOR, DME	16cP	16cP	CARRIER PLATE IN ENGINE COMPARTMENT	D/E4.7.B53
T34	14	HEATER, AIR CONDITIONER	6cM	6cM	IN LUGGAGE COMPARTMENT RIGHT	G23/24
T35	12	CONVERTIBLE TOP	12cL	12cL	BEHIND SIDE PANEL COVERING	K73/74
T36	6	REAR WINDOW	15bM	15bM	BELOW THE PARCEL TRAY	09.028
T38	7	NO.4, FRONT LIGHTS	3cL	3cL	IN WHEEL HOUSING FRONT RIGHT	C5/6
T39	5	NO.4, FRONT LIGHTS	3cL	3cL	IN WHEEL HOUSING FRONT RIGHT	C6/7
T40	30	AUTOMATIC TRANSMISSION	9eP	9eP	UNDER THE SEAT LEFT	H124/125
T41	12	AUTOMATIC TRANSMISSION	9eP	9eP	UNDER THE SEAT LEFT	C/D50.E127
T42	6	REAR PACKAGE TRAY	9eM	9eM	UNDER THE SEAT RIGHT	H16

M - NUMBERS

- M 139 ADJUSTABLE SEAT HEATING, LEFT SEAT
- M 193 JAPAN VERSION
- M 249 AUTOMATIC TRANSMISSION
- M 340 ADJUSTABLE SEAT HEATING, RIGHT SEAT
- M 383 SPORT SEAT LEFT ELECTRIC HEIGHT ADJUSTMENT
- M 387 SPORT SEAT RIGHT ELECTRIC HEIGHT ADJUSTMENT
- M 425 REAR WINDOW WIPER
- M 437 COMFORT SEAT LEFT
- M 438 COMFORT SEAT RIGHT
- M 439 ELECTRIC CONVERTIBLE TOP
- M 454 CRUISE CONTROL
- M 513 LUMBAR SUPPORT SEAT RIGHT
- M 553 USA - CANADA VERSION
- M 562 AIRBAG
- M 573 AIR CONDITIONING SYSTEM
- M 576 WITHOUT REAR FOG LIGHT
- M 586 LUMBAR SUPPORT SEAT LEFT
- M 602 HIGH MOUNTED STOP LIGHT
- M 650 SUN ROOF
- M 659 ON-BOARD COMPUTER

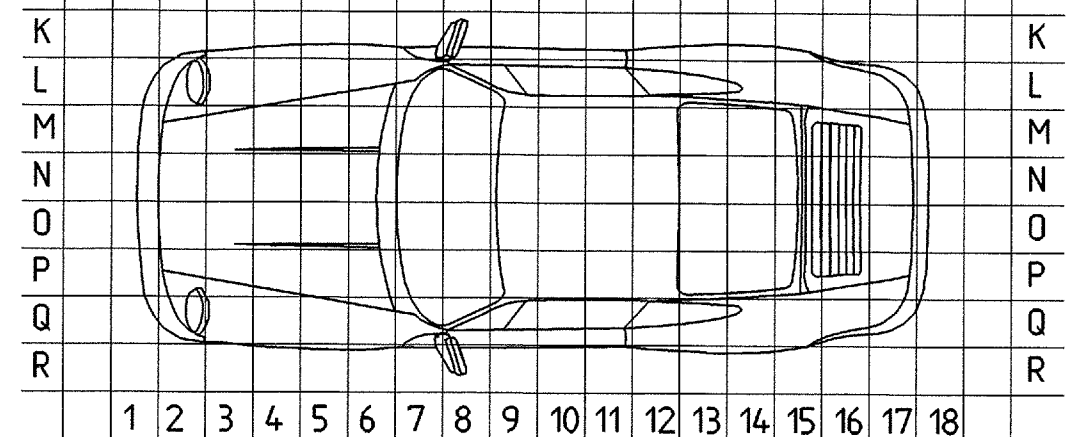
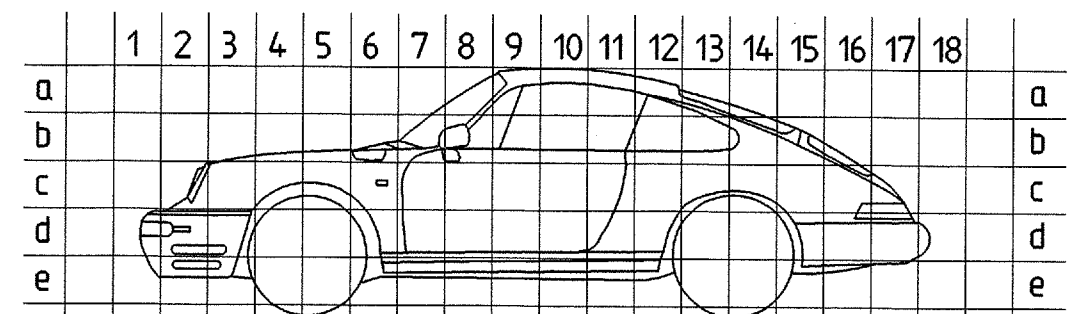

GROUND POINTS

CODE	NOTE	POSITION IN VEHICLE
		LHD
GP I	LUGGAGE COMPARTMENT, WHEEL HOUSING LEFT	2cP
GP II	LUGGAGE COMPARTMENT, WHEEL HOUSING RIGHT	2cM
GP III	ON FIREWALL	—
GP IV	GROUND FOR POWER CONSUMERS, UNDER SEAT LEFT	11eP
GP V	ELECTRONICS, UNDER SEAT LEFT	10eP
GP VI	CENTRAL ELECTRICS, ON SIDE MEMBER RIGHT	6bL
GP VII	ANTENNA AMPLIFIER ON SIDE MEMBER LEFT	7bL
GP VIII	INSIDE LIGHT CONVERTIBLE, ROOF CENTRE FRONT	9aN
GP IX	INSIDE LIGHT, ROOF RIGHT	11aL
GP IX	INSIDE LIGHT, ROOF LEFT	11aP
GP X	BATTERY, LUGGAGE COMPARTMENT LEFT	3eP
GP XI	GROUND STRAP (STARTER, TRANSMISSION, ENGINE, BODY)	14cM
GP XII	ENGINE COMPARTMENT REAR LEFT	15cQ
GP XIII	MOTOR LEFT	15cO
GP XIV	ENGINE COMPARTMENT REAR RIGHT	15cL
GP XV	INSTRUMENTS, SIDE MEMBER LEFT	7bQ
GP XVI	COMBINED LEAD REAR LEFT	13dP
GP XVII	COMBINED LEAD REAR RIGHT	12dM
GP XVIII	COMBINED LEAD FRONT RIGHT	4cM
GP XIX	COMBINED LEAD FRONT LEFT	4cP
GP XX	SEAT CROSS MEMBER, UNDER SEAT RIGHT	8eL
GP XXI	GROUND FOR POWER CONSUMERS, CONNECTION CRANK CASE	16cNO
GP XXII	ELECTRONICS, CONNECTION CRANK CASE	16cNO

ABBREVIATIONS

CODE	MEANING	CODE	MEANING
ABS	ANTILOCK BRAKING SYSTEM	PIN	PIN
AC	AIR CONDITIONING SYSTEM	POT	POTENTIOMETER
SS	SPEED SENSOR	PSD	PORSCHE LIMITED SLIP DIFFERENTIAL
DEF	DEFROST	ROK	TIRE PRESSURE CONTROL
ESO	ENGINE-SPEED SENSOR OUTPUT	ROW	REST OF WORLD
DME	DIGITAL ENGINE ELECTRONICS	RHD	RIGHT-HAND DRIVE
EZK	ELECTRIC IGNITION SYSTEM WITH KNOCK CONTROL	CL	CLOSE
FCU	FREQUENCY CONVERTER UNIT	SA	SAUDI ARABIA
RA	REAR AXLE	CU	CONTROL UNIT
HF	HIGH FREQUENCY	WP	WELD POINT
RL	REAR LEFT	HCS	HEADLIGHT CLEANING SYSTEM
RR	REAR RIGHT	PL	PLUG
IC	INSTRUMENT CLUSTER	DP	DISCONNECTING POINT
TE	TERMINAL	USA	USA
SCS	COMBINED STEERING COLUMN SWITCH	FA	FRONT AXLE
WL	WIRING LOOM	FL	FRONT LEFT
LED	LIGHT-EMITTING DIODE	FR	FRONT RIGHT
LHD	LEFT-HAND DRIVE	CP	CONNECTING POINT
GP	GROUND POINT	WW	WORLDWIDE
LF	LOW FREQUENCY	CES	CENTRAL ELECTRICS
FOG	FOG LIGHT	ADL	ADDITIONAL DRIVING LIGHTS
NO	NUMBER	CLS	CENTRAL LOCKING SYSTEM
RFL	REAR FOG LIGHT		
NTC	NEGATIVE TEMPERATURE COEFFICIENT		
OP	OPEN		

A B C D E F G H J K L M N O P

ADDITIONAL WIRING DIAGRAM TRAILER COUPLING

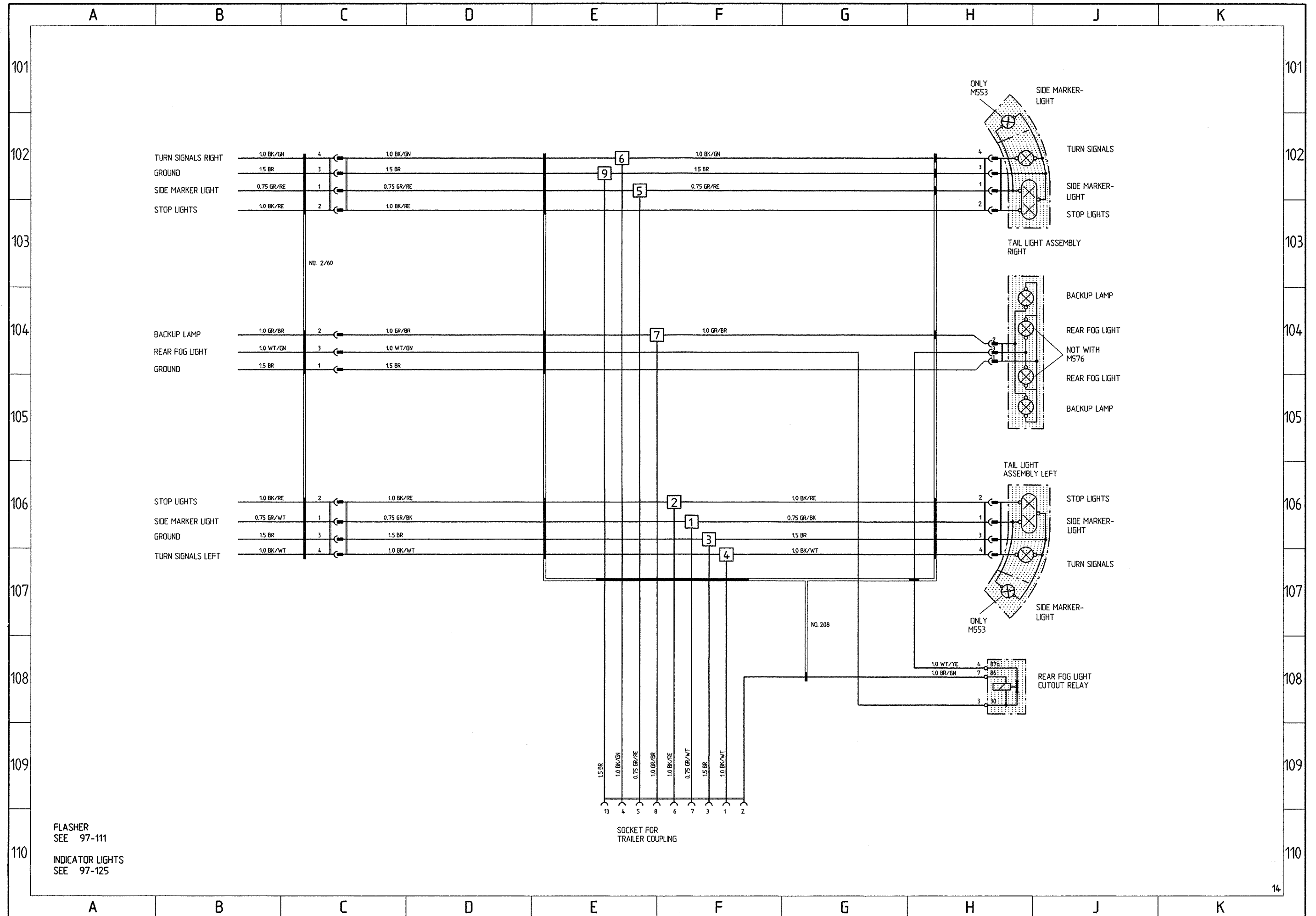

AIRBAG

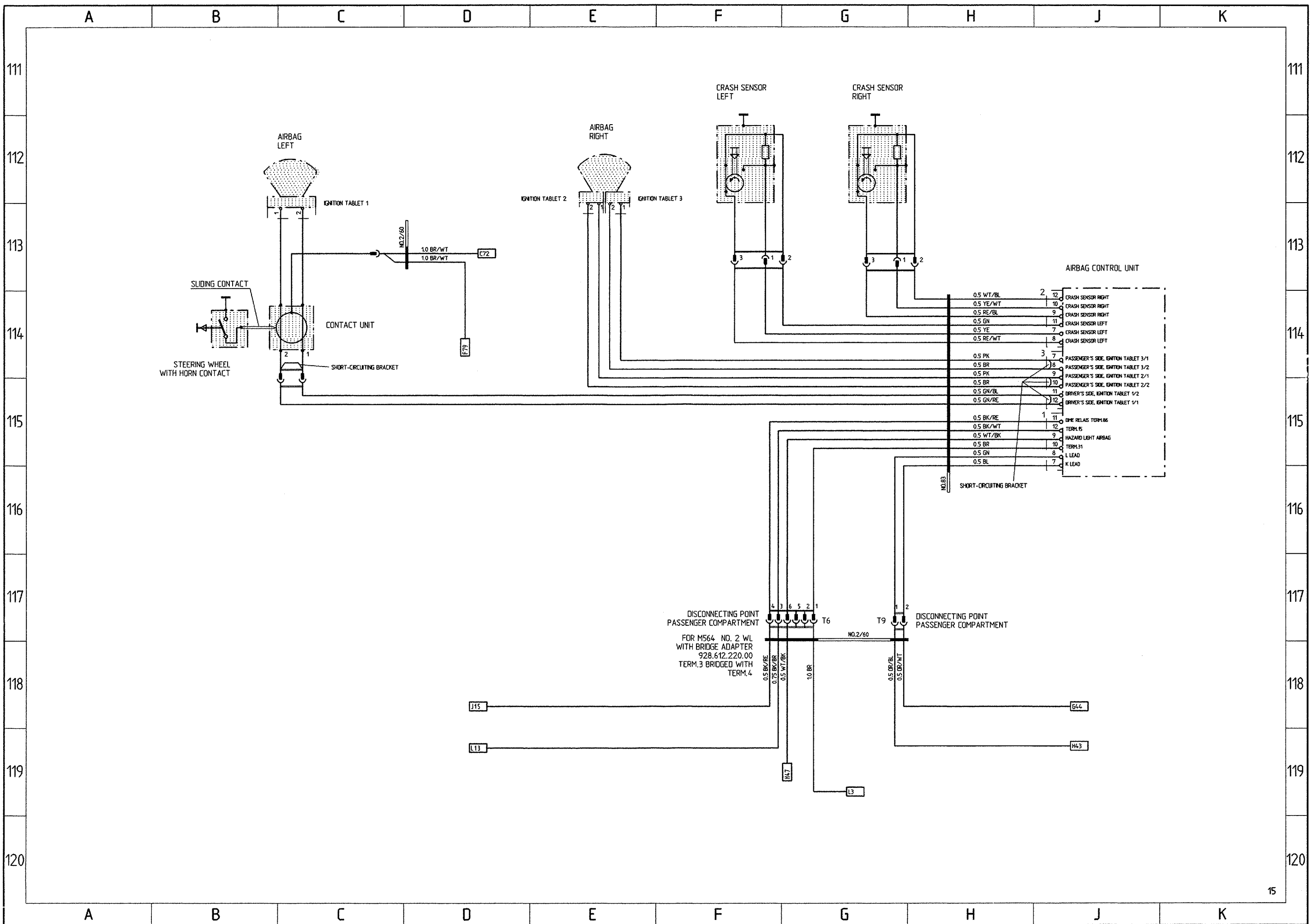

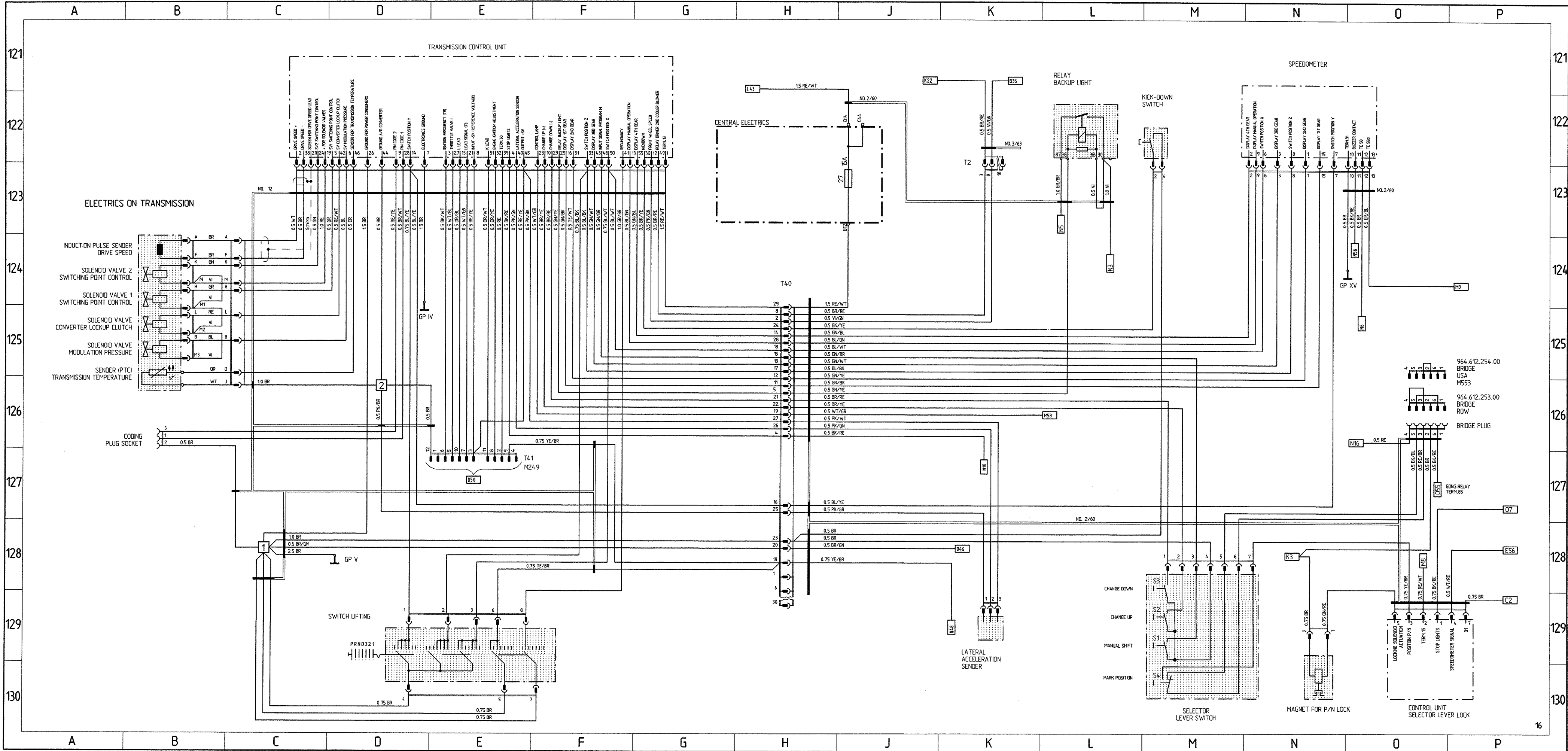

DIFFERENT CIRCUITS

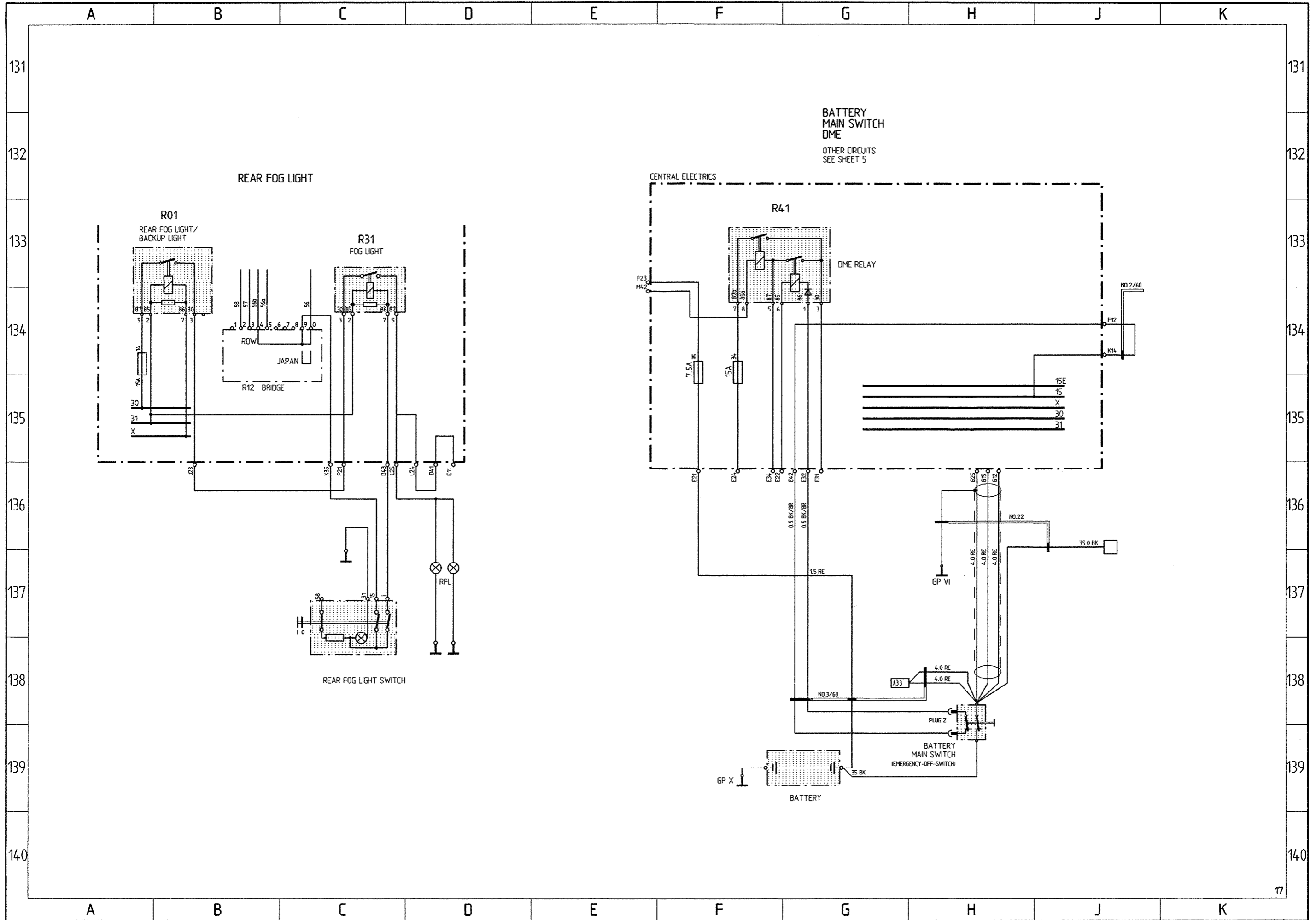

Changes to the circuit diagram for the 911 Carrera 2/4, model 92**Sheet 6, M - P 53/54**

Wire from gong relay pin 4 to clock 1/14 is deleted

Wire from gong relay pin 5 to clock 1/14 is added.

Please alter the circuit diagram accordingly.

Wiring Diagram

Type 911 Carrera 2 and 4 Model 93

	Coordinates	
Sheet 1	1 - 10	Lights
Sheet 2	11 - 20	Alarm System, Central Locks, Mirror, Power Window Regulator, Inside Lights
Sheet 3	21 - 30	Heater, AC, Coolant Fan, Rear Window De-fogger
Sheet 4	31 - 40	ABS, Porsche Dynamic AWD Control (Carrera 4)
Sheet 4a	31 - 40	ABS (Carrera 2)
Sheet 4b	31 - 40	ABS Turbo look (Carrera 2)
Sheet 5	41 - 50	Motor, Ignition, Cruise Control
Sheet 6	51 - 60	Instruments, Sensor, Central Informer, On-board computer
Sheet 7	61 - 70	Seats
Sheet 8	71 - 80	Rear Spoiler, Two-Tone Horns, Wipe- and Wash Cleaners, Sun Roof, Convertible Top
Sheet 9	81 - 90	Radio, Telephone
Sheet 10	91 - 100	Fog Light, Rear Fog Light
Sheet 11		Central Electric
Sheet 12		Construction Components
Sheet 13		Plug Connections, Ground Points, M-Numbers, Abbreviations
Sheet 14	101 - 110	Trailer Coupling
Sheet 15	111 - 120	Airbag
Sheet 16	121 - 130	Tiptronic (Carrera 2)
Sheet 17	131 - 140	911 Carrera RS

Wiring Diagram

Type 911 Carrera 2 and 4 Model 93

The wiring diagram consists of *12 individual wiring diagrams*, 1 sheet *construction components* and 1 sheet *plug connections and ground points*. These are divided into coordinate fields.

Each individual wiring diagram contains a part of the central-electrics box in a dashdotted frame.

This part of the central-electrics box shows all the lines and relays necessary for the individual wiring diagram.

The earth/ground points are identified by "GP" and their location is shown in a vehicle diagram.

The 10-pin connectors on the central-electrics box are clipped together out of 3 parts, the 20-pin connectors are clipped together out of 5 parts.

Part 1, with the moduled-on fastening lug, is the "starting element".

Parts 2,3 and 4 are "module elements".

The 10-pin connectors only contents one "module element".

Start- and module elements are identified by the numbers 1.....5.

Part 5 ist a "coding element".

The designations of the plug connections in the wiring diagram refer to the "starting element" from, for example, B 11.....15, and to the first module element from B 21.....25.

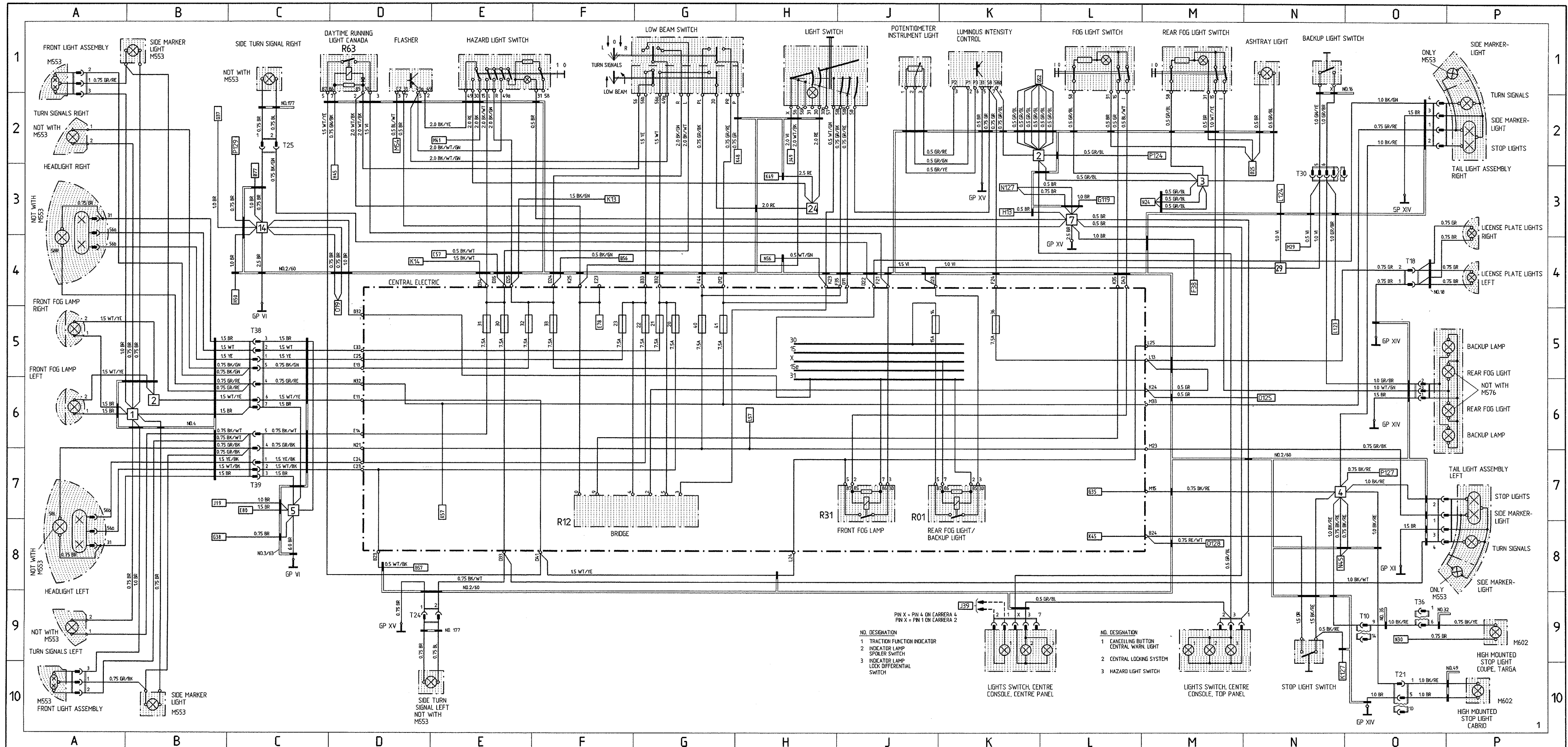

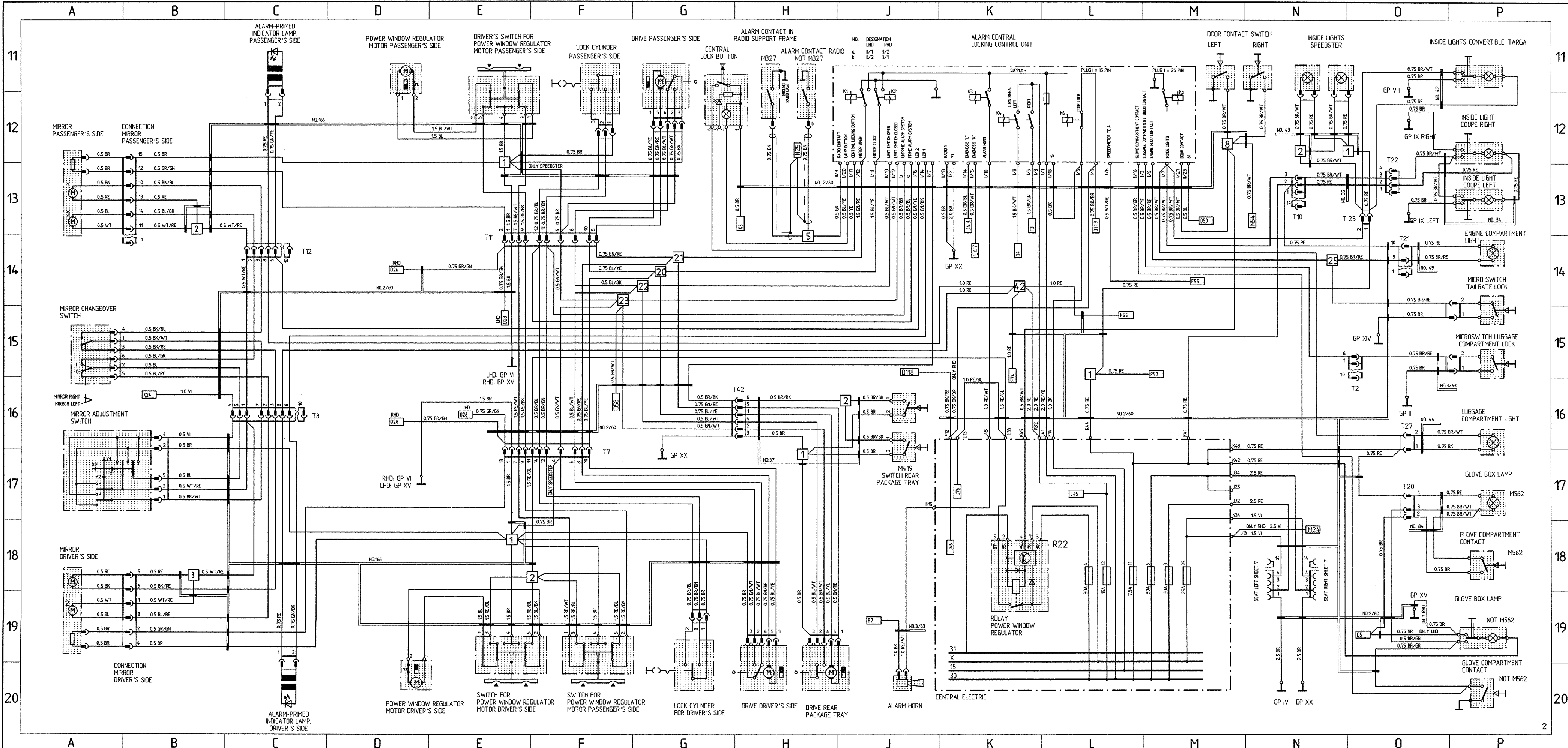

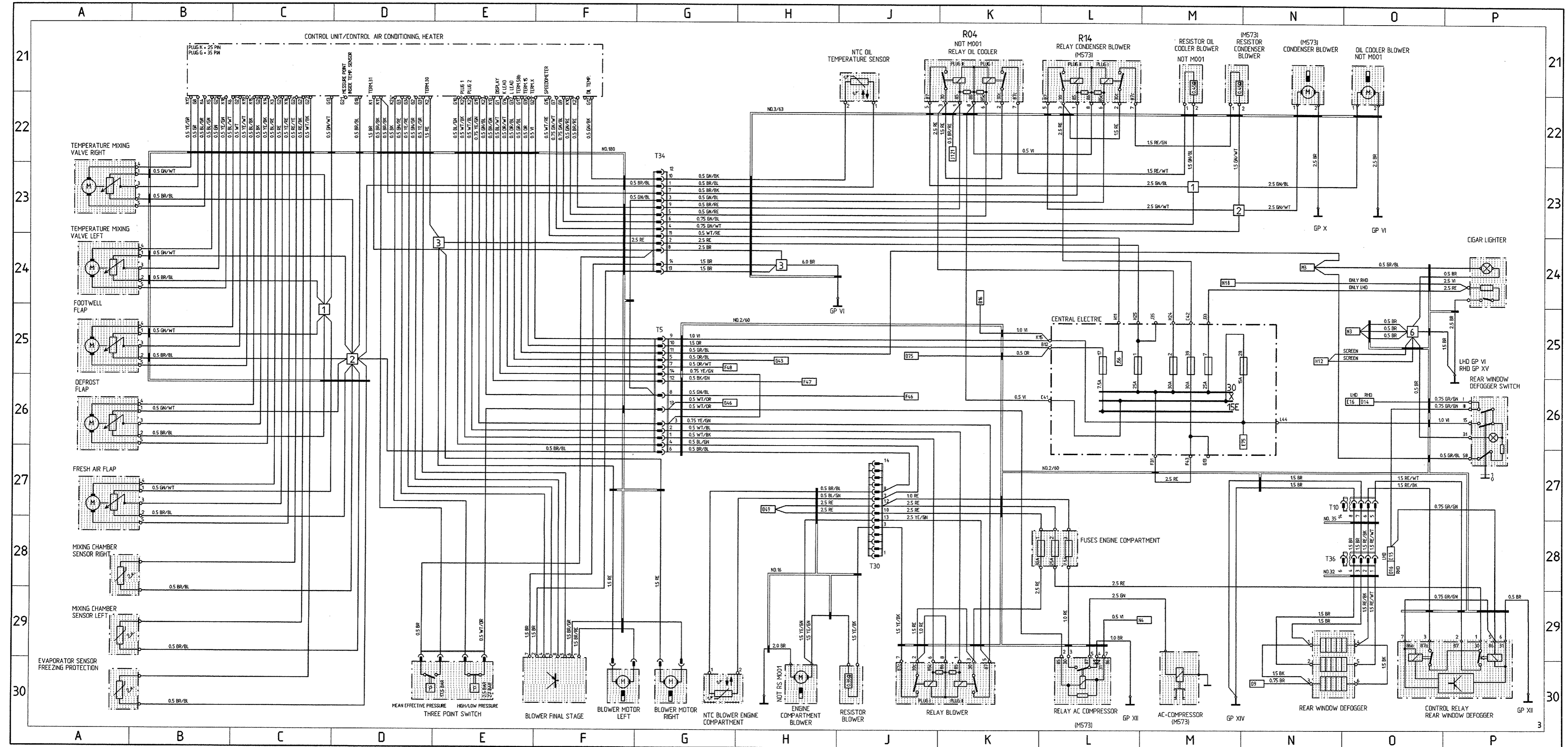

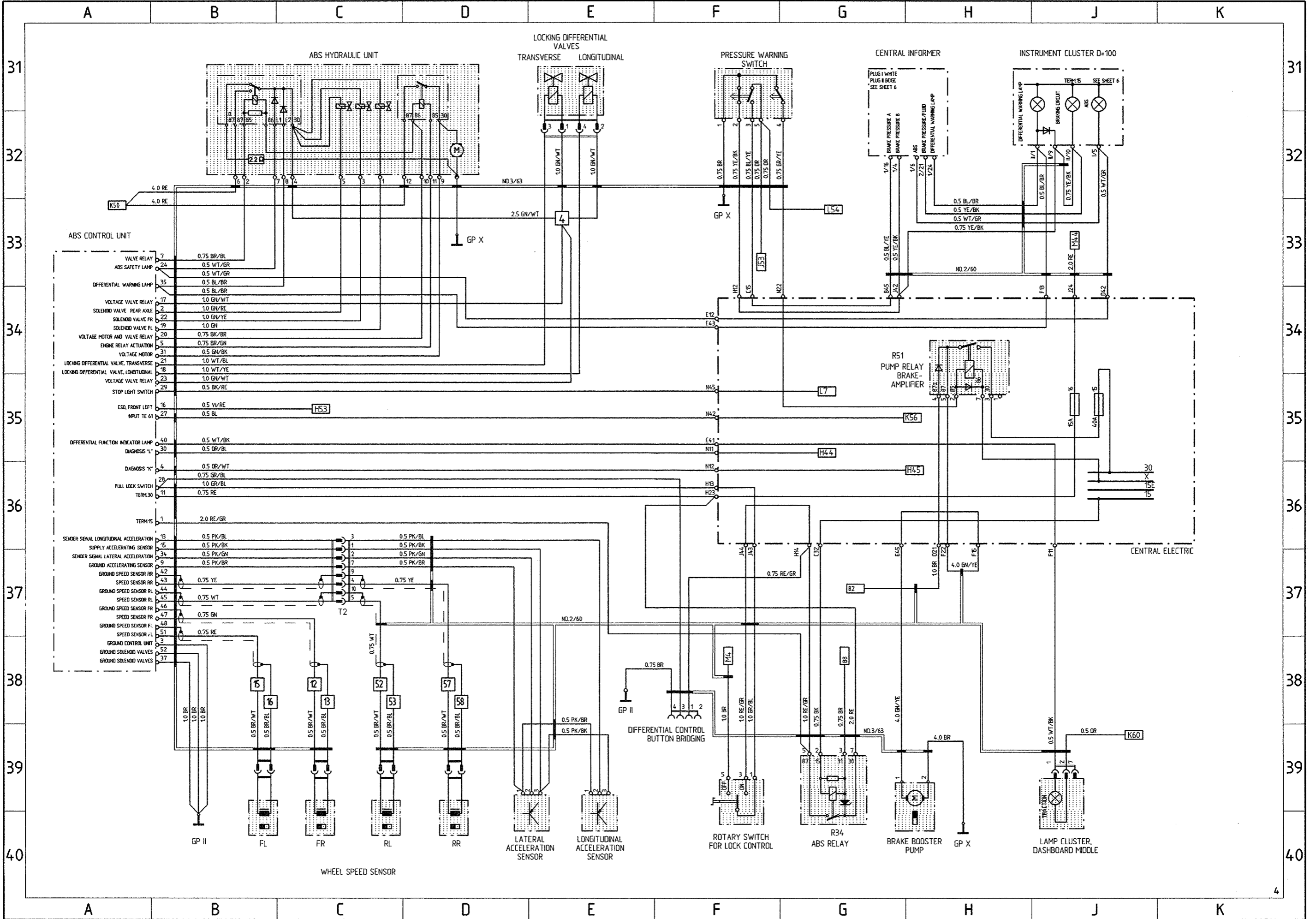

ABS

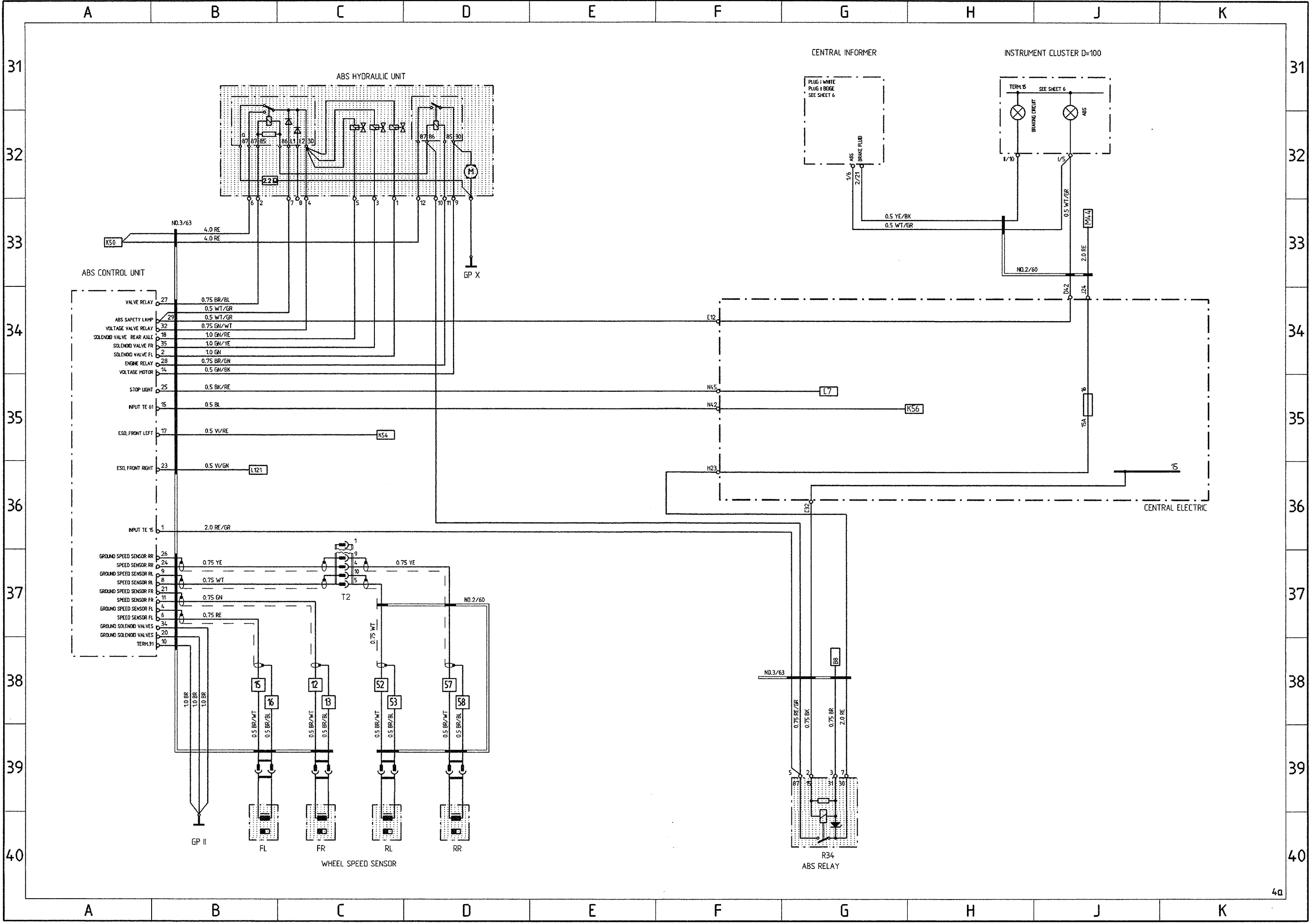

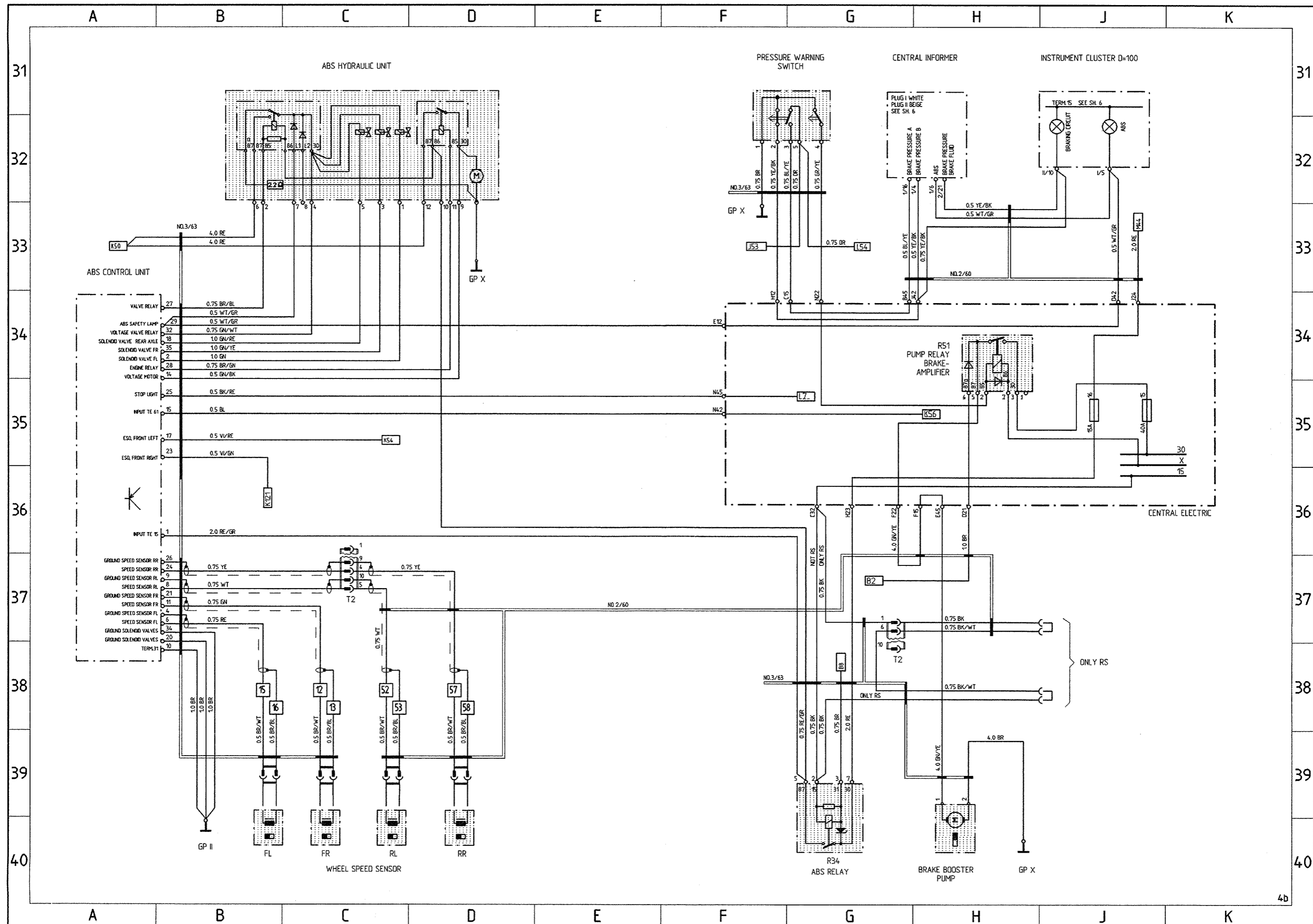

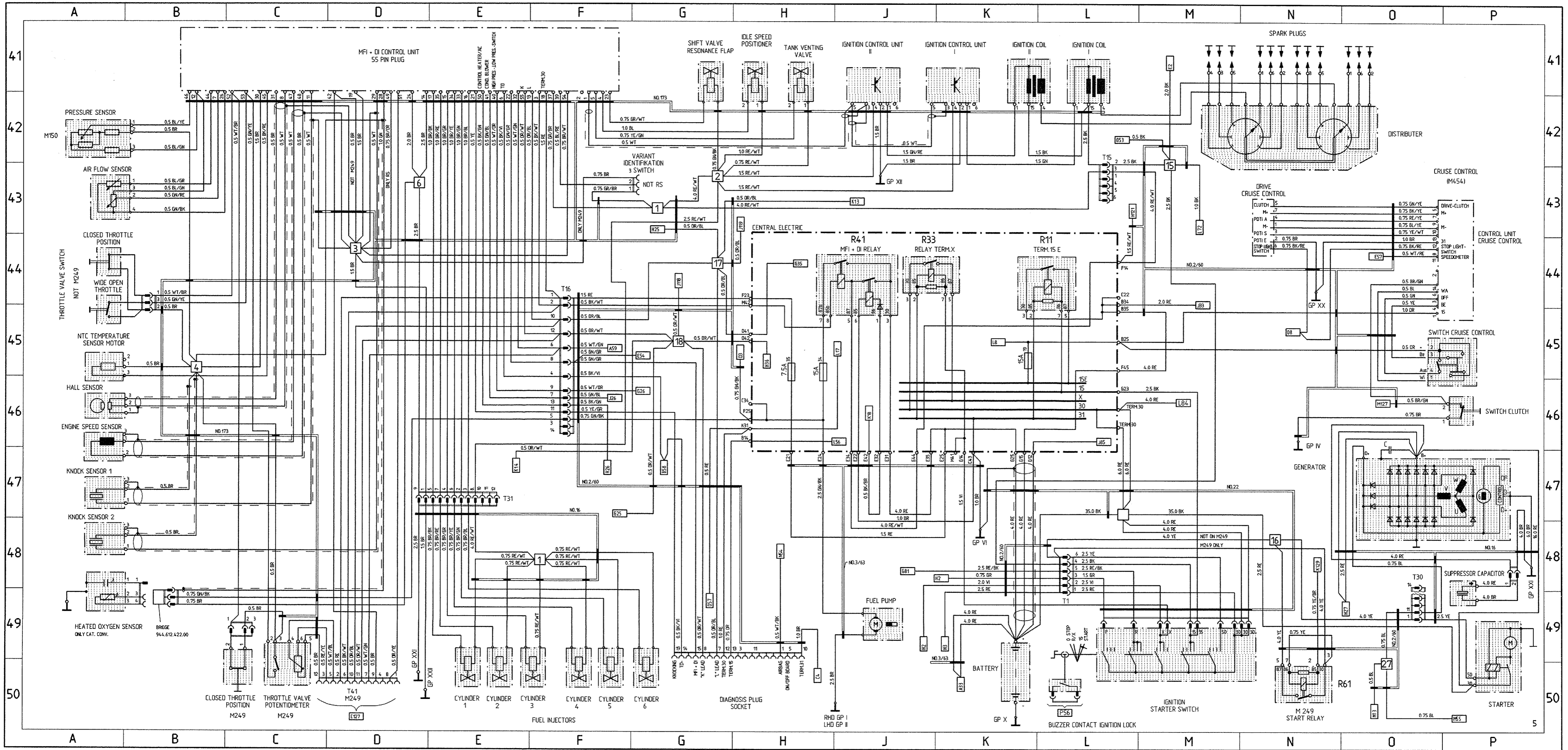

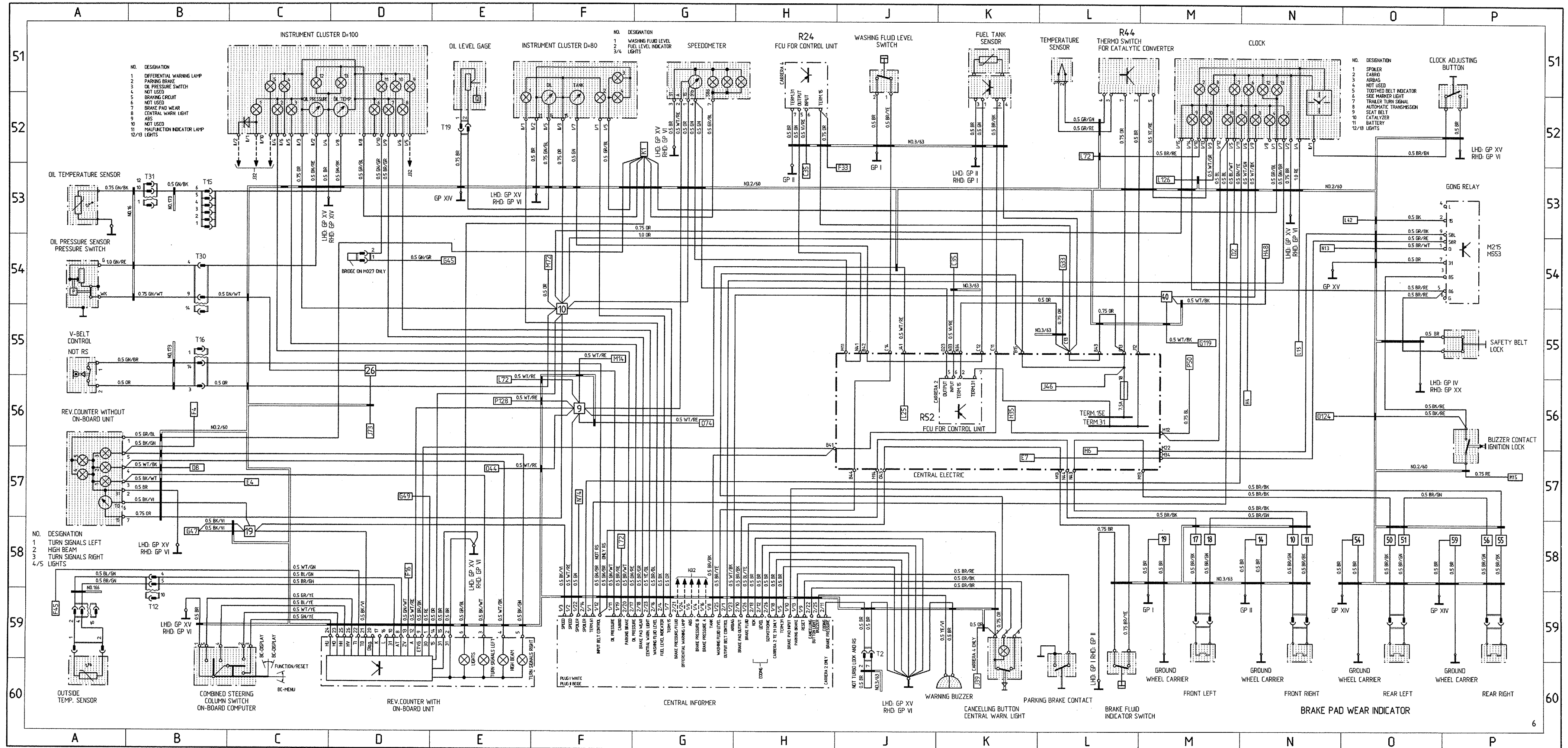

SEATS

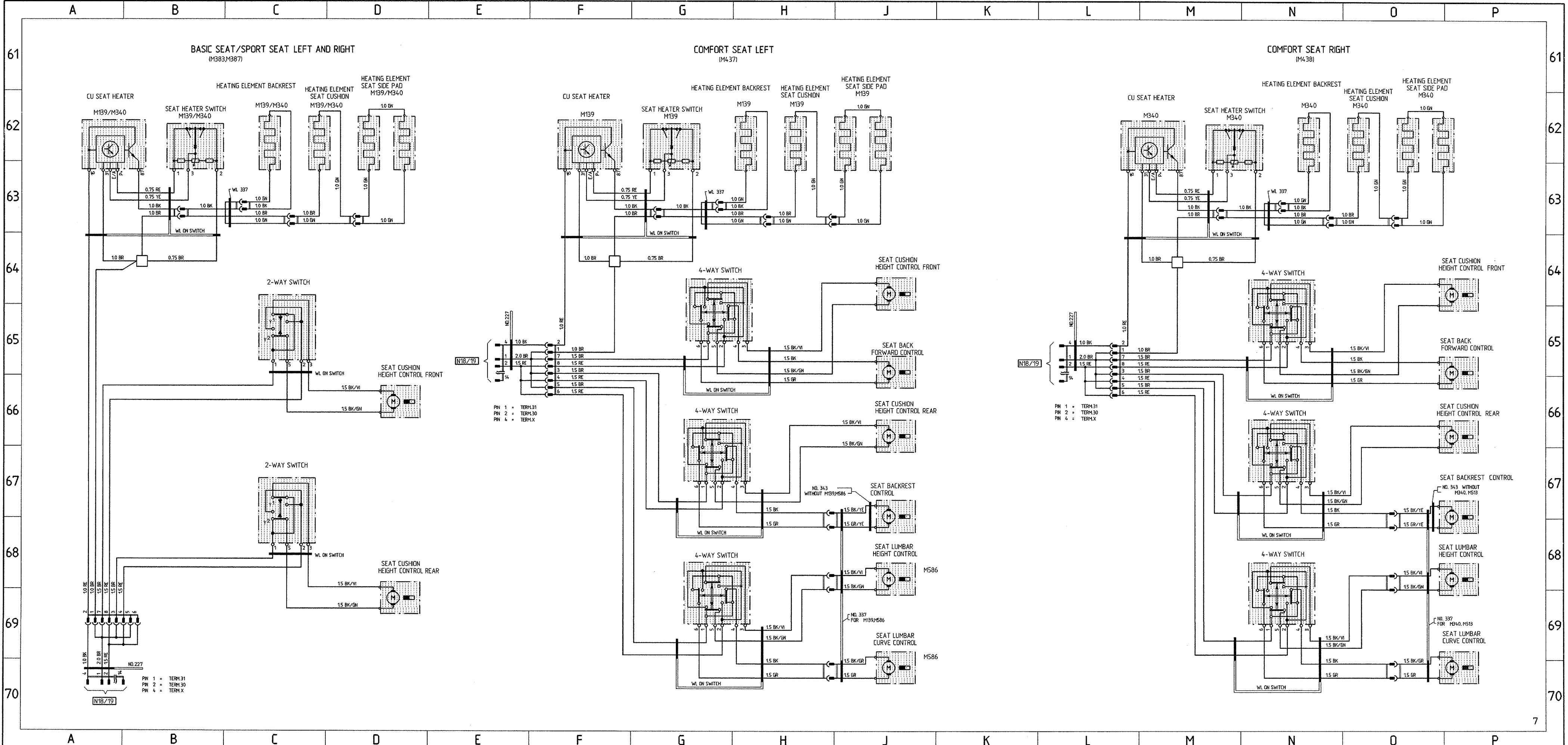

REAR SPOILER, TWO-TONE HORNS, WIPE- AND WASH CLEANERS, SUN ROOF, CONVERTIBLE TOP

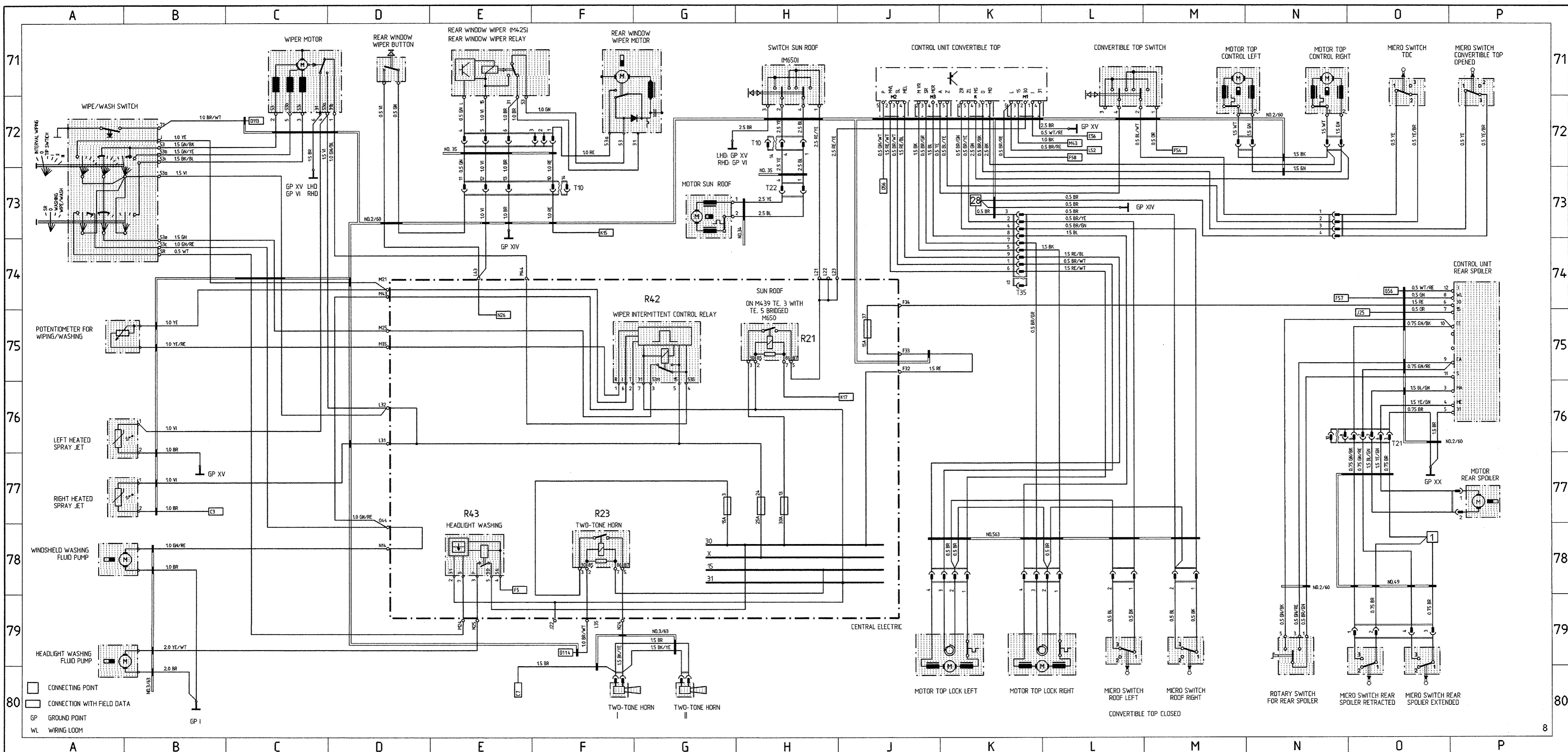

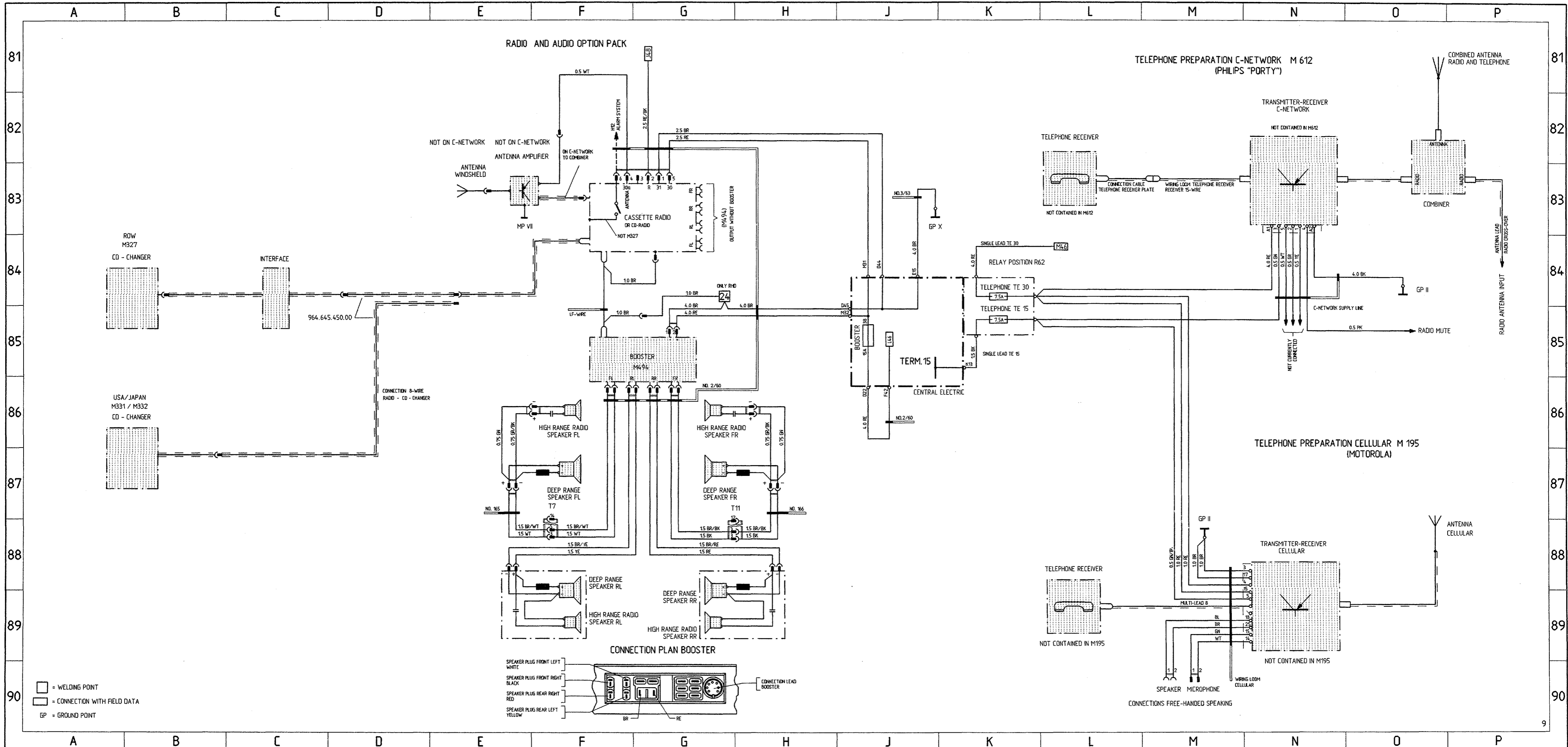

FOG LIGHT, REAR FOG LIGHT

FOG LIGHT- AND REAR FOG LIGHT-WIRINGS

ROW
FOG LIGHT +
REAR FOG LIGHT FROM 58

M487-NORWAY
FOG LIGHT + REAR FOG LIGHT
ONLY WITH 57

M553-USA
FOG LIGHT WITH 56b + 57

M193 JAPAN
FOG LIGHT +
REAR FOG LIGHT FROM 58

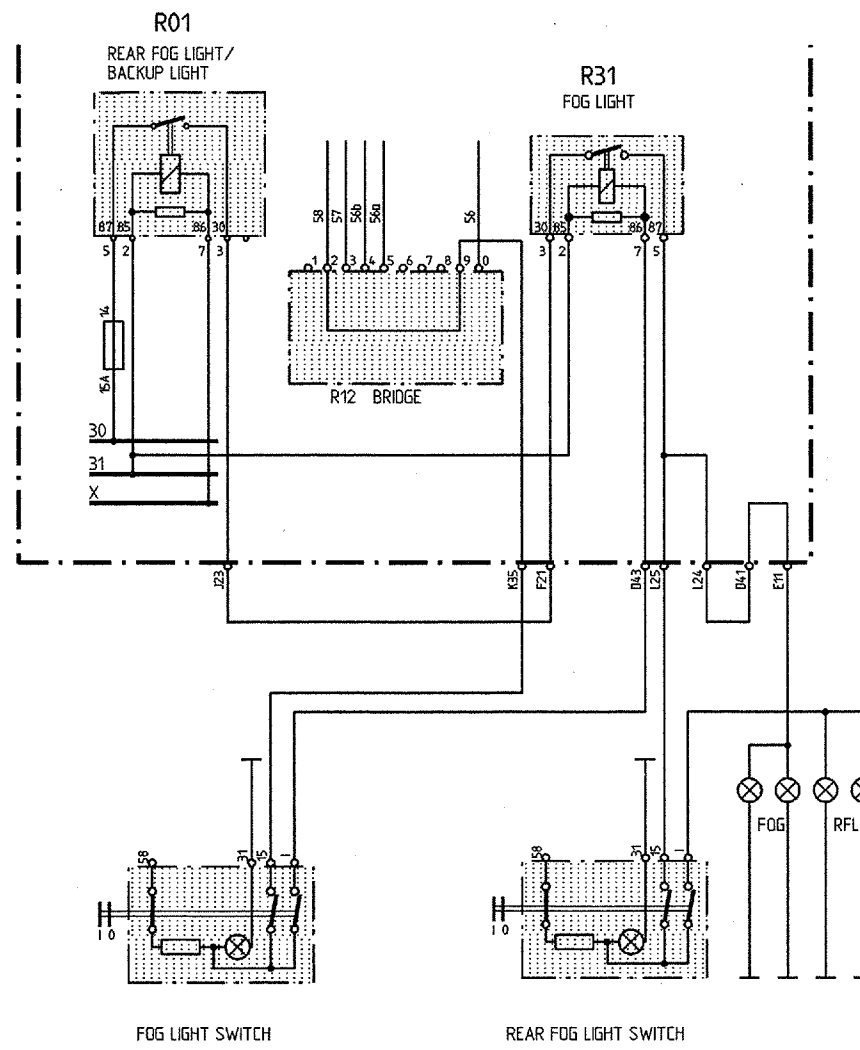
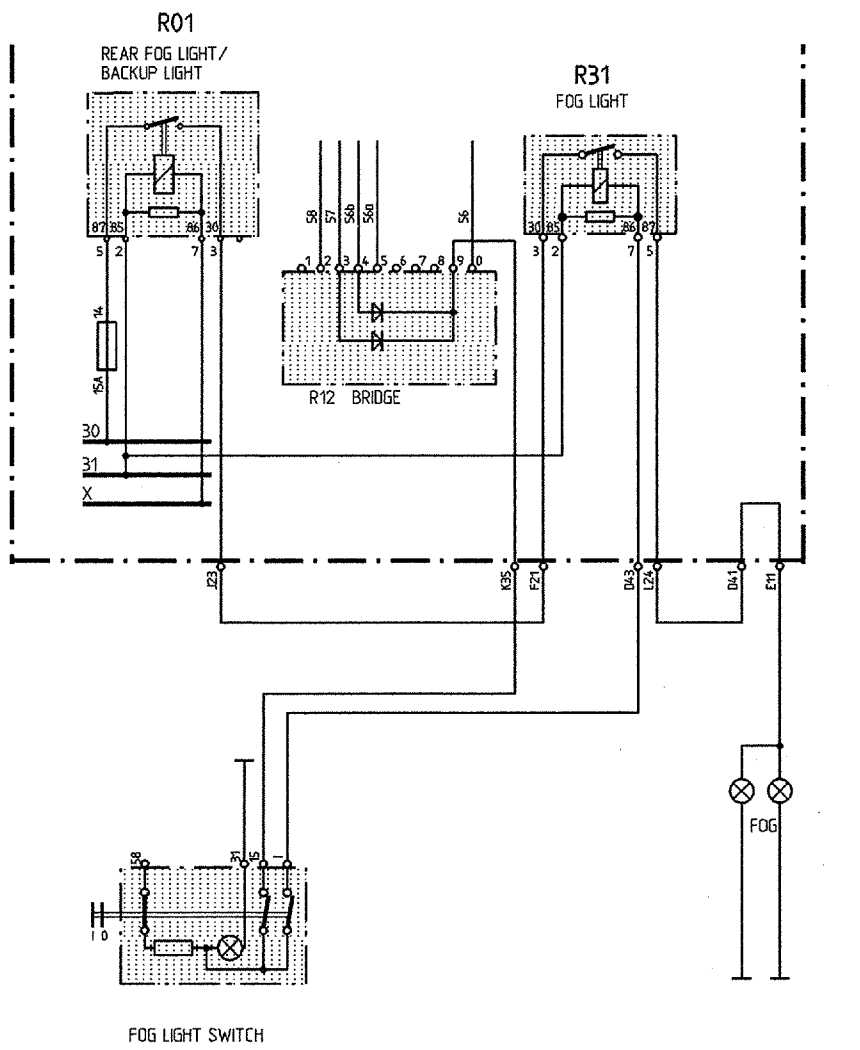
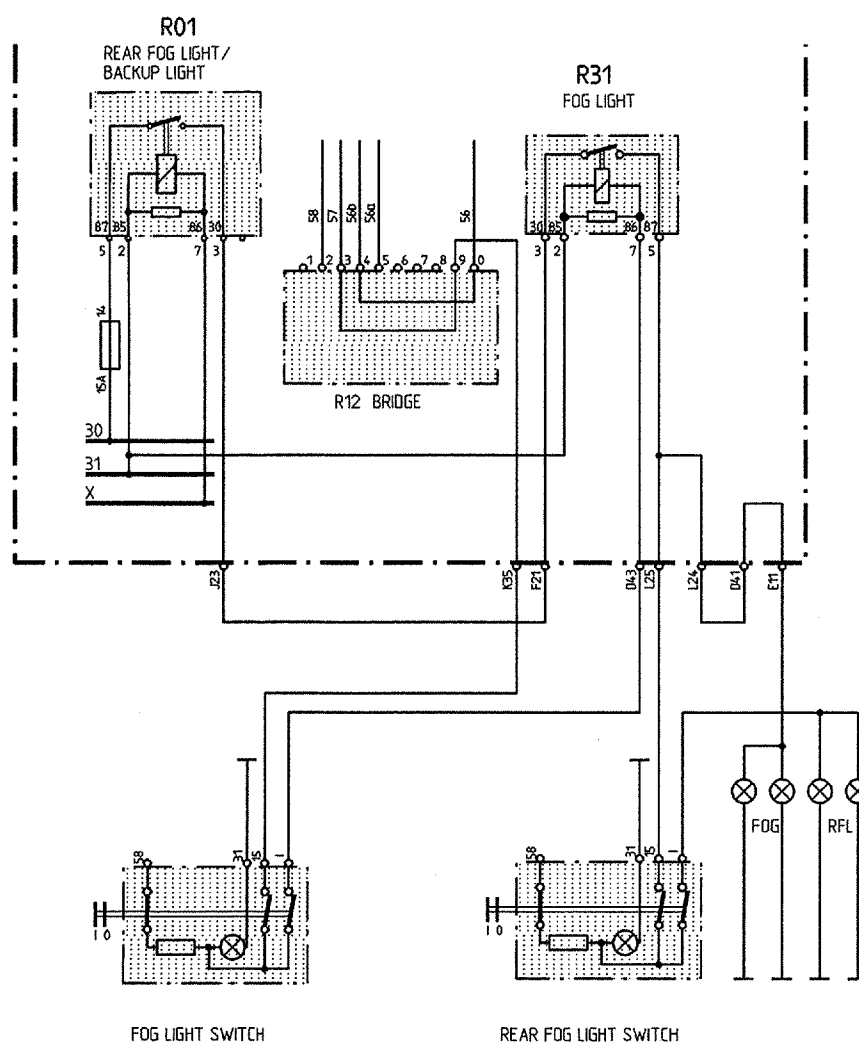
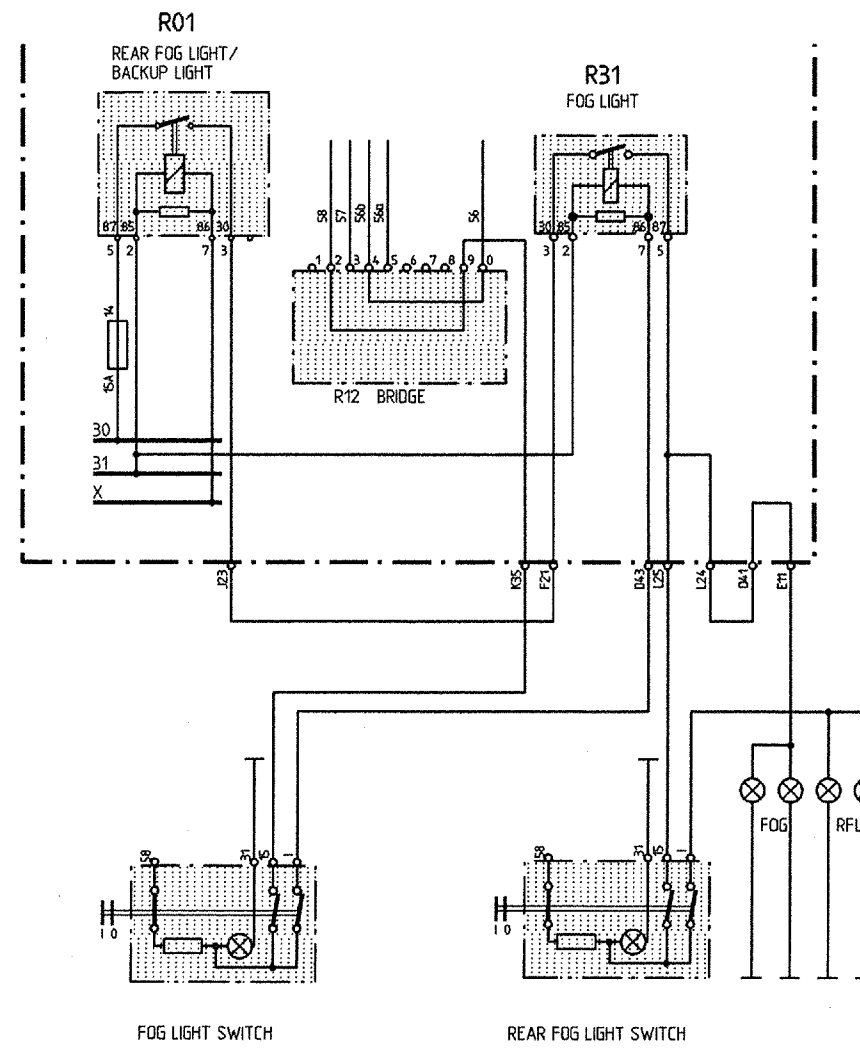

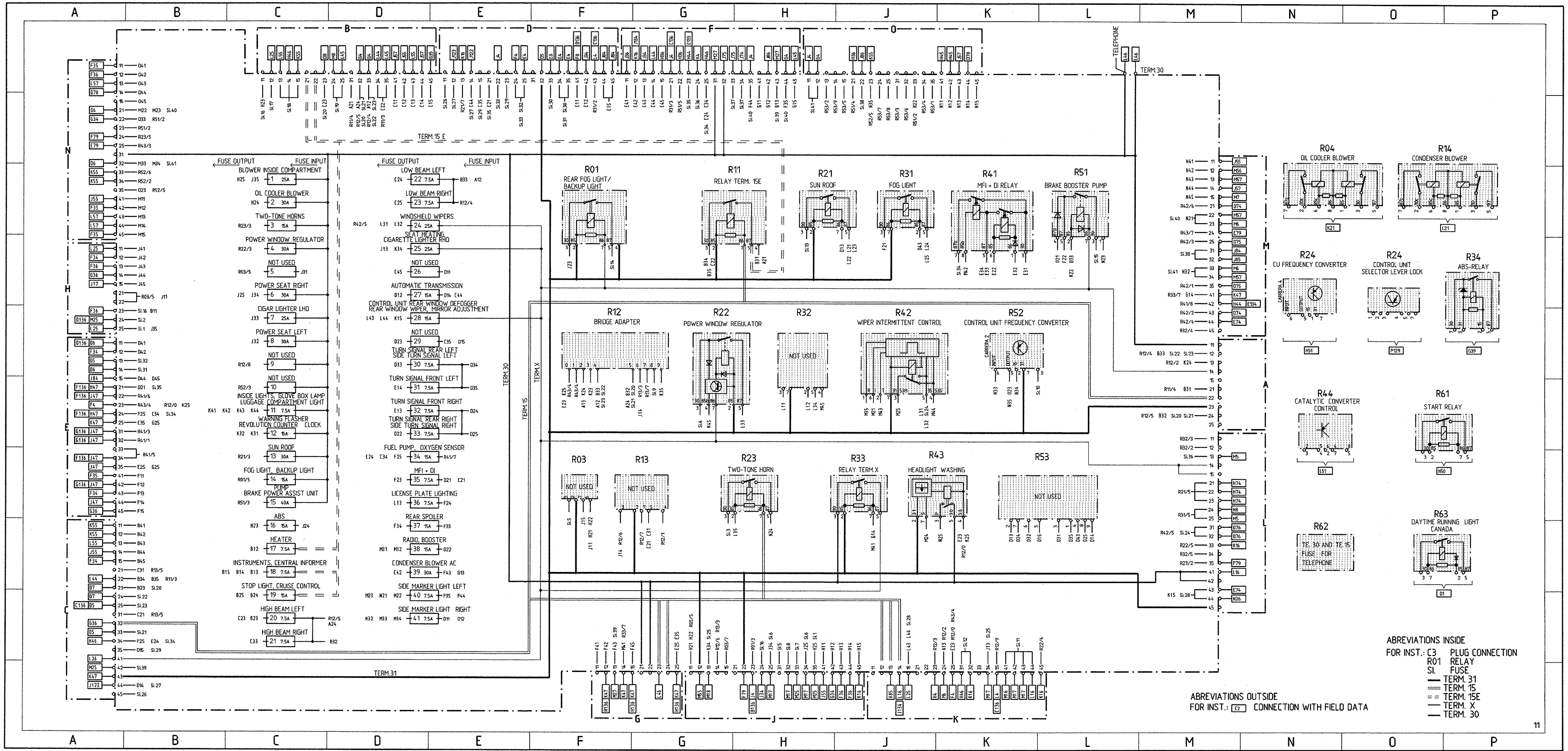

CONSTRUCTION COMPONENTS

DESIGNATION, FUNCTION	POSITION IN VEHICLE		NOTE	FIELD IN WIRING DIAGRAM
	LHD	RHD		
ABS RELAY	6cM	6cM	CENTRAL ELECTRIC	G39/40
AIR FLOW SENSOR	16bD	16bD	ON ENGINE	A43
ALARM HORN	3cL	3cL	IN WHEEL HOUSING FRONT RIGHT	J20
ANTENNA AMPLIFIER	7bL	7bD	IN LUGGAGE COMPARTMENT	E/F83
BACKUP LIGHT SWITCH	14dN	14dN	BY TRANSMISSION RIGHT	N1
BATTERY MAIN SWITCH RS	2dN	2dN	IN LUGGAGE COMPARTMENT	H138/139
BLOWER ENGINE COMPARTMENT	16cD	16cD	ON ENGINE	H30
BLOWER FINAL STAGE	6bN	6bN	IN LUGGAGE COMPARTMENT	F30
BLOWER MOTOR LEFT	6cP	6cP	IN LUGGAGE COMPARTMENT	F30
BLOWER MOTOR RIGHT	6cM	6cM	IN LUGGAGE COMPARTMENT	G30
BOOSTER	9eM	9eM	UNDER THE SEAT RIGHT	F/G85
BRAKE BOOSTER PUMP	1dD	1dD	IN LUGGAGE COMPARTMENT	H39/40
BUZZER CONTACT	7cP	7cM	ON IGNITION LOCK	P56
CENTRAL ELECTRIC	6cM	6cM	IN LUGGAGE COMPARTMENT	---
CENTRAL INFORMER	6cP	6cP	ON STEERING COLUMN	H32,F/G/H59
CLUTCH SWITCH CRUISE CONTROL	6dP	6dN	BY CLUTCH PEDAL UNDER FLOOR PANEL	P46
CONDENSER BLOWER	2dD	2dD	IN WHEEL HOUSING FRONT LEFT	N21
CONTROL RELAY REAR WINDOW DEFOGGER	16cP	16cP	CARRIER PLATE IN ENGINE COMPARTMENT	O/P29/30
CONTROL UNIT ABS	2dM	2dM	IN LUGGAGE COMPARTMENT	A33-38
CONTROL UNIT AIRBAG	6cD	6cD	ON INSTRUMENT PANEL	J114/115
CONTROL UNIT ALARM SYSTEM/CENTRAL LOCKING SYSTEM	9eM	9eM	UNDER THE SEAT RIGHT	J-M12
CONTROL UNIT AUTOMATIC TRANSMISSION	10dP	10dP	UNDER THE SEAT LEFT	C-G122
CONTROL UNIT CONVERTIBLE TOP	6cP	6cP	ON INSTRUMENT PANEL	J/K71
CONTROL UNIT CRUISE CONTROL	9eN	9eN	UNDER THE SEAT RIGHT	P43/44
CONTROL UNIT INSTRUMENT LIGHT	7bD	7bD	IN LUGGAGE COMPARTMENT LEFT	K1
CONTROL UNIT HEATING AIR CONDITIONING	7cD	7cN	ON INSTRUMENT PANEL	B-F21
CONTROL UNIT REAR SPOILER	6cM	6cP	INSIDE FIREWALL RIGHT/LEFT	P74-76
CONTROL UNIT SELECTOR LEVER LOCK	6cM	6cM	CENTRAL ELECTRIC	O/P129/130
CRASH SENSOR LEFT	4cP	4cP	IN LUGGAGE COMPARTMENT	F112/113
CRASH SENSOR RIGHT	4cM	4cM	IN LUGGAGE COMPARTMENT	G112/113
DIAGNOSIS CONNECTION	7cL	7cD	IN PASSENGER'S FOOTWELL	G/H50
DRIVE CRUISE CONTROL	15cD	15cD	ON ENGINE	N43/44
ENGINE SPEED SENSOR	15cP	15cP	BY ENGINE LEFT	A46/47
FLASHER	7dN	7dN	IN CENTRE CONSOLE	D1
FUEL LEVEL SENSOR	5cM	5cP	IN FUEL TANK	K51
FUEL PUMP	6eM	6eP	BEHIND THE BASE	J49
FUSES ENGINE COMPARTMENT	16cP	16cP	CARRIER PLATE IN ENGINE COMPARTMENT	L28
GONG RELAY	6cP	---	BY STEERING COLUMN LEFT	P53/54
HALL SENSOR	17cD	17cD	ON DISTRIBUTOR	A46
HEADLIGHT CLEANER PUMP	3cQ	3cQ	BY WASHING FLUID RESERVOIR IN WHEEL HOUSING FL	A79/80
HEADLIGHT CLEANER RELAY	6cM	6cM	CENTRAL ELECTRIC	E78
HYDRAULIC UNIT ABS	3dP	3dP	IN LUGGAGE COMPARTMENT	C32
IDLE SPEED POSITIONER	15bN	15bN	IN ENGINE COMPARTMENT	H41
IDLE SPEED SWITCH AUTOMATIC TRANSMISSION	15bN	15bN	ON ENGINE	C50
IGNITION COIL I	15cD	15cD	IN ENGINE COMPARTMENT LEFT	L41
IGNITION COIL II	15cD	15cD	IN ENGINE COMPARTMENT LEFT	K41
IGNITION CONTROL UNIT I	15cP	15cP	IN ENGINE COMPARTMENT LEFT	K41
IGNITION CONTROL UNIT II	15cP	15cP	IN ENGINE COMPARTMENT LEFT	J41
KICK-DOWN SWITCH	6dD	6dM	BY ACCELERATOR PEDAL UNDER FLOOR PANEL	M122
KNOCK SENSOR 1	15cP	15cP	BY ENGINE LEFT	A47
KNOCK SENSOR 2	16cN	16cN	BY ENGINE TOP	A48
LATERAL ACCELERATION SENSOR ABS	7dN	7dN	IN CENTRE CONSOLE	D/E40
LATERAL ACCELERATION SENSOR AUTOMAT	7dN	7dN	IN CENTRE CONSOLE	K129
LOCKING DIFFERENTIAL VALVES LONGIT. AND TRANSVERSE	3dM	3dM	IN LUGGAGE COMPARTMENT	---
LONGITUDINAL ACCELERATION SENSOR	7dN	7dN	IN CENTRE CONSOLE	E40
MFI + DI CONTROL UNIT	9eP	9eP	UNDER THE SEAT LEFT	B-F41
MFI + DI RELAY	6cM	6cM	CENTRAL ELECTRIC	J46
MICRO SWITCH FOR TOP CONTROL	12cL	12cL	BEHIND SIDE PANEL COVERING	P71

DESIGNATION, FUNCTION	POSITION IN VEHICLE		NOTE	FIELD IN WIRING DIAGRAM
	LHD	RHD		
MICRO SWITCH REAR SPOILER EXTENDED	16bP	16bP	ON TAILGATE	D79
MICRO SWITCH REAR SPOILER RETRACTED	16bP	16bP	ON TAILGATE	D79
MICRO SWITCH ROOF LEFT	9aD	9aD	AT CONVERTIBLE TOP FRAME	L79
MICRO SWITCH ROOF RIGHT	9aN	9aN	AT CONVERTIBLE TOP FRAME	M79
MICRO SWITCH TDC	12cL	12cL	BEHIND SIDE PANEL COVERING	O71
MOTOR TOP CONTROL LEFT	15cD	15cD	BEHIND REAR SEAT	M/N71
MOTOR TOP CONTROL RIGHT	15cN	15cN	BEHIND REAR SEAT	N71
MOTOR TOP LOCK LEFT	9aD	9aD	AT CONVERTIBLE TOP FRAME	J/K79
MOTOR TOP LOCK RIGHT	9aN	9aN	AT CONVERTIBLE TOP FRAME	K/L79
MOTOR SUN ROOF	12aN	12aN	IN ROOF	E73
NTC HEATER FAN	16cP	16cP	IN ENGINE COMPARTMENT	G30
OIL COOLER BLOWER	2dL	2dL	IN WHEEL HOUSING FRONT RIGHT	Q21
OIL LEVEL GAGE	12cK	12cK	IN WHEEL HOUSING REAR RIGHT	E51/52
OIL PRESSURE SENSOR/SWITCH	14cN	14cN	ON ENGINE	A54
OIL TEMPERATURE SENSOR COOLING FAN	2dL	2dL	IN WHEEL HOUSING FRONT RIGHT	J21
OIL TEMPERATURE SENSOR FOR INSTRUMENT	14cN	14cN	ON ENGINE	A53
OUTSIDE TEMP. SENSOR	8bK	8bR	IN OUTSIDE MIRROR	A60
PRESSURE SENSOR	10eP	10eP	UNDER THE SEAT LEFT	A42
PRESSURE SWITCH AIR CONDITIONING SYSTEM	6bD	6bD	IN LUGGAGE COMPARTMENT	D/E30
PRESSURE WARNING SWITCH	1dD	1dD	IN LUGGAGE COMPARTMENT	F/G31/32
REAR FOG LIGHT CUTOFF RELAY	17dN	17dN	BEHIND REAR PANEL	H108
REAR WINDOW WIPER RELAY	15bD	15bD	ON REAR WINDOW WIPER MOTOR	E71
RELAY AC COMPRESSOR	16cP	16cP	CARRIER PLATE IN ENGINE COMPARTMENT	L30
RELAY BACKUP LIGHT	7bQ	7bQ	IN LUGGAGE COMPARTMENT LEFT	L122
RELAY BLOWER ENGINE COMPARTMENT	16cP	16cP	CARRIER PLATE IN ENGINE COMPARTMENT	J/K30
RELAY BRAKE BOOSTER PUMP	6cM	6cM	CENTRAL ELECTRIC	H34/35
RELAY CONDENSER BLOWER	6cM	6cM	CENTRAL ELECTRIC	L21
RELAY FREQUENCY TRANSFORMER	6cM	6cM	CENTRAL ELECTRIC	K56/H51
RELAY FRONT FOG LAMP	6cM	6cM	CENTRAL ELECTRIC	J7
RELAY DAYTIME RUNNING LIGHT CANADA	6cM	6cM	CENTRAL ELECTRIC	D1
RELAY OIL COOLER BLOWER	6cM	6cM	CENTRAL ELECTRIC	K21
RELAY POWER WINDOW REGULATOR	6cM	6cM	CENTRAL ELECTRIC	K18/19
RELAY REAR FOG LIGHT- BACKUP LIGHT	6cM	6cM	CENTRAL ELECTRIC	J/K7
RELAY STARTER AUTOMATIC TRANSMISSION	6cM	6cM	CENTRAL ELECTRIC	N50
RELAY SUN ROOF	6cM	6cM	CENTRAL ELECTRIC	H75
RELAY TERM.X	6cM	6cM	CENTRAL ELECTRIC	K44
RELAY TERM.Y	6cM	6cM	CENTRAL ELECTRIC	K/L44
RELAY THERMO SWITCH CATALYTIC CONVERTER	6cM	6cM	CENTRAL ELECTRIC	L/M51
RELAY TWO-TONE HORN	6cM	6cM	CENTRAL ELECTRIC	F78
RESISTOR BLOWER	16dP	16dP	IN ENGINE COMPARTMENT	J30
RESISTOR FOR BLOWER CONDENSER	2dQ	2dQ	IN WHEEL HOUSING FRONT LEFT	M21
RESISTOR OIL COOLER BLOWER	2dL	2dL	IN WHEEL HOUSING FRONT RIGHT	M21
SHIFT VALVE RESONANCE FLAP	15bN	15bN	ON ENGINE	G41
STARTER	14dN	14dN	BY CLUTCH HOUSING RIGHT	P49/50
STOP LIGHT SWITCH	6dP	6dM	AT THE BRAKE PEDAL BELOW THE FLOOR PANEL	N9
SWITCH LIFTING	12dD	12dD	ON GEARBOX	D-F129
TANK VENTING VALVE	15cN	15cN	BY ENGINE TOP	H41
TEMPERATURE MOTOR	15cP	15cP	BY ENGINE LEFT	A45
THROTTLE VALVE POTENTIOMETER, AUTOM. TRANSMISSION	15bN	15bN	ON THROTTLE VALVE ASSEMBLY	C50
THROTTLE VALVE SWITCH, MANUAL TRANSMISSION	15bN	15bN	ON THROTTLE VALVE ASSEMBLY	A44/45
TWO-TONE HORN I	3cL	3cL	IN WHEEL HOUSING FRONT RIGHT	F80
TWO-TONE HORN II	3cL	3cL	IN WHEEL HOUSING FRONT RIGHT	G80
VARIANT IDENTIFICATION SWITCH	9eP	9eP	UNDER THE SEAT LEFT	G43
V-BELT CONTROL	17dO	17dO	ON ENGINE	A55/56
WARNING BUZZER	7cP	7cP	ON INSTRUMENT PANEL	K60
WINDSHIELD WASHING FLUID PUMP	3cQ	3cQ	BY WASHING FLUID RESERVOIR IN WHEEL HOUSING FL	A78
WINDSHIELD WASHING FLUID PUMP RS	4cM	4cD	IN LUGGAGE COMPARTMENT	A78
WIPER INTERMITTENT CONTROL RELAY	6cM	6cM	CENTRAL ELECTRIC	F/G75

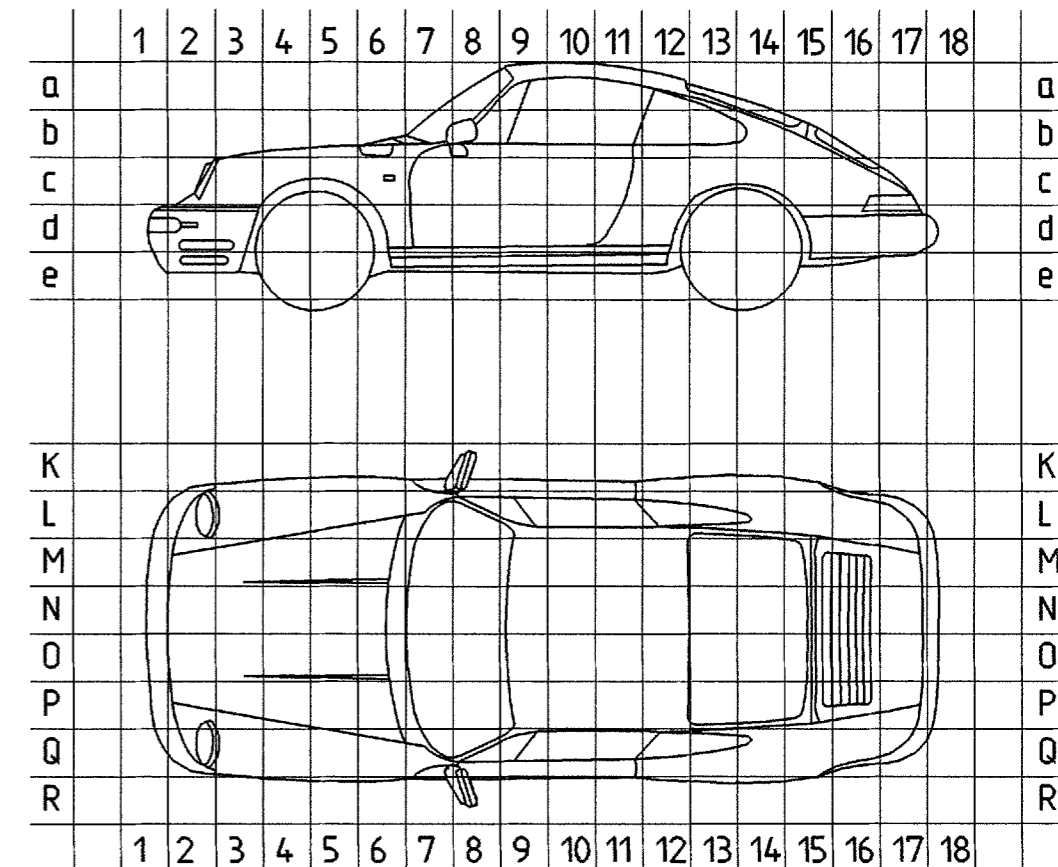

PLUG CONNECTIONS

CODE	NUMBER OF PINS	DESIGNATION, FUNCTION	POSITION IN VEHICLE		NOTE	FIELD
			LHD	RHD		
T1	6	IGNITION LOCK	6cP	6cM	BY STEERING COLUMN LEFT	L48
T2	10	ABS	6cL	6cL	IN LUGGAGE COMPARTMENT RIGHT	C36/37, K122, D15
T5	14	HEATER, AIR CONDITIONER	6cM	6cM	UNDER INSTRUMENT PANEL RIGHT	G25/26
T6	6	AIRBAG	7dN	7dN	IN CENTRE CONSOLE	F/517
T7	14	DOOR DRIVER'S SIDE	6cQ	6cL	UNDER INSTRUMENT PANEL LEFT	F88.E/F17
T8	10	DOOR DRIVER'S SIDE	6cQ	6cL	UNDER INSTRUMENT PANEL LEFT	C16
T9	2	AIRBAG	7dN	7dN	IN CENTRE CONSOLE	G17
T10	14	REAR WINDOW SHELF	12cL	12cL	BEHIND SIDE PANEL COVERING	O9,N13,027.E/F73,H72
T11	12	DOOR PASSENGER'S SIDE	6cL	6cQ	UNDER INSTRUMENT PANEL RIGHT	E14,H88
T12	10	DOOR PASSENGER'S SIDE	6cL	6cQ	UNDER INSTRUMENT PANEL RIGHT	B59,L14
T15	6	MFI + DI	9eP	9eP	UNDER THE SEAT LEFT	L43,B53
T16	14	MFI + DI	9eP	9eP	UNDER THE SEAT LEFT	F45/46,B55
T18	2	LICENSE PLATE LIGHTS	17dL	17dL	TAIL LIGHTS RIGHT	D4
T19	2	OIL LEVEL GAGE	15cM	15cM	IN ENGINE COMPARTMENT RIGHT	E52
T20	3	GLOVE BOX LAMP AIRBAG	6cL	—	UNDER INSTRUMENT PANEL RIGHT	D17
T21	10	TAILGATE	15cL	15cL	IN ENGINE COMPARTMENT RIGHT	N76,D14,D10
T22	4	INSIDE LIGHTS, SUN ROOF	15bM	15bM	BELOW THE PARCEL TRAY	H73,D13
T23	2	INSIDE LIGHTS CONVERTIBLE, TARGA	6cQ	6cQ	UNDER INSTRUMENT PANEL LEFT	D13
T24	2	SIDE TURN SIGNAL LEFT	7bD	7bD	IN LUGGAGE COMPARTMENT ON SIDE MEMBER LEFT	D/E9
T25	2	SIDE TURN SIGNAL RIGHT	7bL	7bL	IN LUGGAGE COMPARTMENT ON SIDE MEMBER RIGHT	C2
T27	2	LUGGAGE COMPARTMENT LIGHT	7bL	7bL	IN LUGGAGE COMPARTMENT ON SIDE MEMBER RIGHT	D16
T30	14	NO. 16 MOTOR	16cP	16cP	CARRIER PLATE IN ENGINE COMPARTMENT	N/D03,J27/28,048/49,B54
T31	12	MOTOR, MFI+DI	16cP	16cP	CARRIER PLATE IN ENGINE COMPARTMENT	D/E47,B53
T34	14	HEATER, AIR CONDITIONER	6cM	6cM	IN LUGGAGE COMPARTMENT RIGHT	G23/24
T35	12	CONVERTIBLE TOP	12cL	12cL	BEHIND SIDE PANEL COVERING	K73/74
T36	6	REAR WINDOW	15bM	15bM	BELOW THE PARCEL TRAY	O9,028
T38	7	NO. 4, FRONT LIGHTS	3cL	3cL	IN WHEEL HOUSING FRONT RIGHT	C5/6
T39	5	NO. 4, FRONT LIGHTS	3cL	3cL	IN WHEEL HOUSING FRONT RIGHT	C6/7
T40	30	AUTOMATIC TRANSMISSION	9eP	9eP	UNDER THE SEAT LEFT	H124/125
T41	12	AUTOMATIC TRANSMISSION	9eP	9eP	UNDER THE SEAT LEFT	C/D50,E127
T42	6	REAR PACKAGE TRAY	9eM	9eM	UNDER THE SEAT RIGHT	H16

M - NUMBERS

- M 139 ADJUSTABLE SEAT HEATING, LEFT SEAT
- M 193 JAPAN VERSION
- M 215 SAUDI-ARABIA VERSION
- M 249 AUTOMATIC TRANSMISSION
- M 340 ADJUSTABLE SEAT HEATING, RIGHT SEAT
- M 383 SPORT SEAT LEFT ELECTRIC HEIGHT ADJUSTMENT
- M 387 SPORT SEAT RIGHT ELECTRIC HEIGHT ADJUSTMENT
- M 425 REAR WINDOW WIPER
- M 437 COMFORT SEAT LEFT
- M 438 COMFORT SEAT RIGHT
- M 439 ELECTRIC CONVERTIBLE TOP
- M 454 CRUISE CONTROL
- M 513 LUMBAR SUPPORT SEAT RIGHT
- M 553 USA - CANADA VERSION
- M 562 AIRBAG
- M 573 AIR CONDITIONING SYSTEM
- M 576 WITHOUT REAR FOG LIGHT
- M 586 LUMBAR SUPPORT SEAT LEFT
- M 602 HIGH MOUNTED STOP LIGHT
- M 650 SUN ROOF
- M 659 ON-BOARD COMPUTER

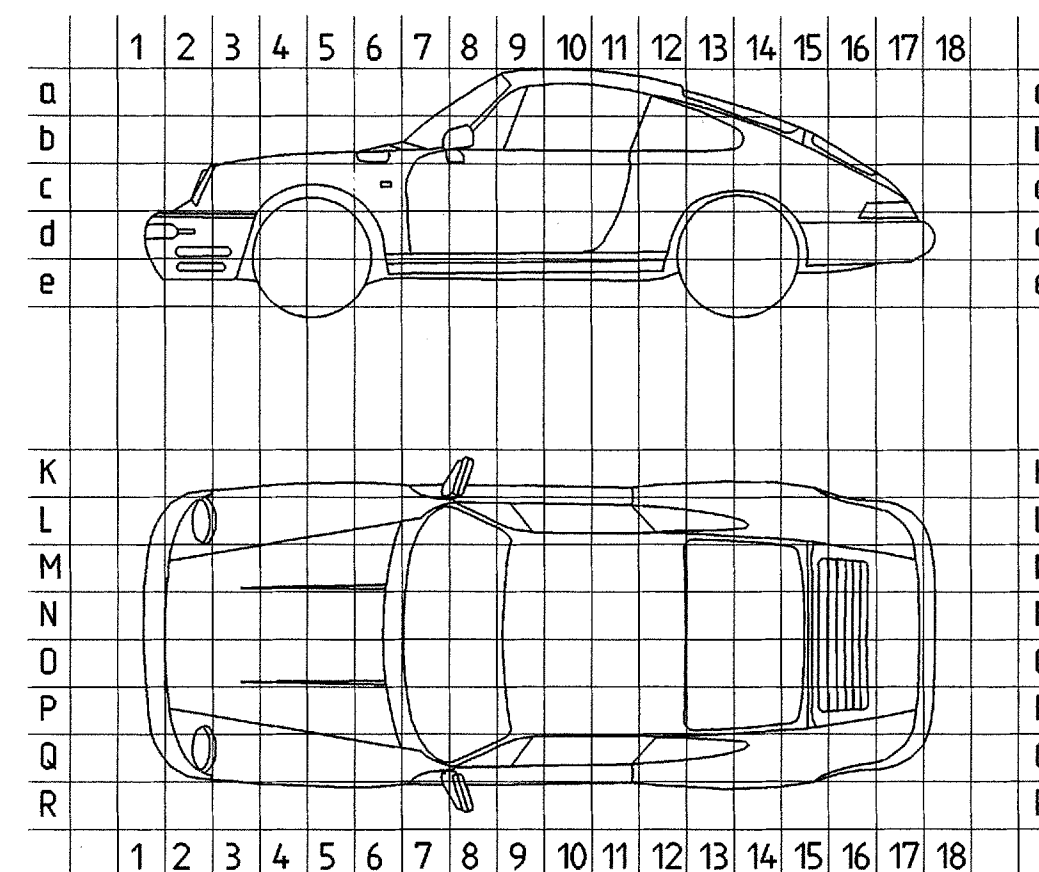

GROUND POINTS

CODE	NOTE	POSITION IN VEHICLE
		LHD
GP I	LUGGAGE COMPARTMENT, WHEEL HOUSING LEFT	2cP
GP II	LUGGAGE COMPARTMENT, WHEEL HOUSING RIGHT	2cM
GP III	ON FIREWALL	—
GP IV	GROUND FOR POWER CONSUMERS, UNDER SEAT LEFT	11eP
GP V	ELECTRONICS, UNDER SEAT LEFT	10eP
GP VI	CENTRAL ELECTRIC, ON SIDE MEMBER RIGHT	6bL
GP VII	ANTENNA AMPLIFIER ON SIDE MEMBER LEFT	7bL
GP VIII	INSIDE LIGHT CONVERTIBLE, ROOF CENTRE FRONT	9aN
GP IX	INSIDE LIGHT, ROOF RIGHT	11aL
GP IX	INSIDE LIGHT, ROOF LEFT	11aP
GP X	BATTERY, LUGGAGE COMPARTMENT LEFT	3eP
GP XI	GROUND STRAP (STARTER, TRANSMISSION, ENGINE, BODY)	14cM
GP XII	ENGINE COMPARTMENT REAR LEFT	15cD
GP XIII	MOTOR LEFT	15cD
GP XIV	ENGINE COMPARTMENT REAR RIGHT	15cL
GP XV	INSTRUMENTS, SIDE MEMBER LEFT	7bD
GP XVI	COMBINED LEAD REAR LEFT	13dP
GP XVII	COMBINED LEAD REAR RIGHT	12dM
GP XVIII	COMBINED LEAD FRONT RIGHT	4cM
GP XIX	COMBINED LEAD FRONT LEFT	4cP
GP XX	SEAT CROSS MEMBER, UNDER SEAT RIGHT	8eL
GP XXI	GROUND FOR POWER CONSUMERS, CONNECTION CRANK CASE	16cND
GP XXII	ELECTRONICS, CONNECTION CRANK CASE	16cND

ABBREVIATIONS

CODE	MEANING	CODE	MEANING
ABS	ANTILOCK BRAKING SYSTEM	ND	NUMBER
ADL	ADDITIONAL DRIVING LIGHTS	NTC	NEGATIVE TEMPERATURE COEFFICIENT
AC	AIR CONDITIONING SYSTEM	OP	OPEN
CE	CENTRAL ELECTRIC	PIN	PIN
CL	CLOSE	PL	PLUG
CLS	CENTRAL LOCKING SYSTEM	POT	POTENTIOMETER
CP	CONNECTING POINT	PSD	PORSCHE LIMITED SLIP DIFFERENTIAL
CU	CONTROL UNIT	RA	REAR AXLE
DEF	DEFROST	RDK	TIRE PRESSURE CONTROL
DI	ELECTRIC IGNITION SYSTEM WITH KNOCK CONTROL	RFL	REAR FOG LIGHT
DP	DISCONNECTING POINT	RHD	RIGHT-HAND DRIVE
ESQ	ENGINE-SPEED SENSOR OUTPUT	RL	REAR LEFT
FA	FRONT AXLE	ROW	REST OF WORLD
FCU	FREQUENCY CONVERTER UNIT	RR	REAR RIGHT
FL	FRONT LEFT	SA	SAUDI ARABIA
FOG	FOG LIGHT	SCS	COMBINED STEERING COLUMN SWITCH
FR	FRONT RIGHT	SS	SPEED SENSOR
GP	GROUND POINT	TE	TERMINAL
HCS	HEADLIGHT CLEANING SYSTEM	USA	USA
HF	HIGH FREQUENCY	WL	WIRING LOOM
IC	INSTRUMENT CLUSTER	WP	WELD POINT
LED	LIGHT-EMITTING DIODE	WW	WORLDWIDE
LF	LOW FREQUENCY		
LHD	LEFT-HAND DRIVE		
MFI + DI	DIGITAL ENGINE ELECTRONICS		

ADDITIONAL WIRING DIAGRAM TRAILER COUPLING

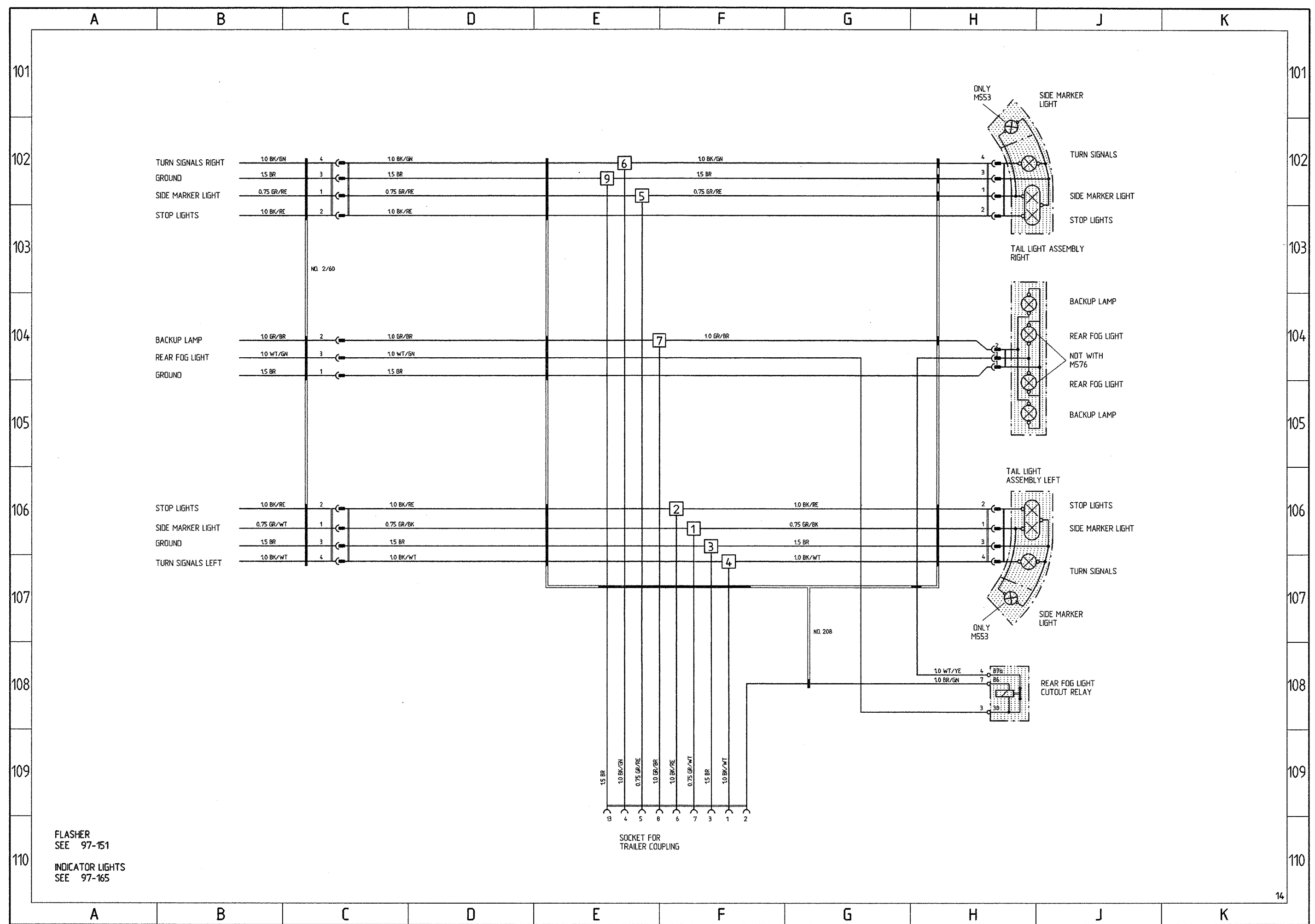

AIRBAG

